

FINAL REPORT - PROJECT EXECUTIVE SUMMARY

ITHACA

DIL Reference: D030

UNCLASSIFIED

Prepared by: Ana GONZALEZ (GMV)
Hans Steffen MARTINEZ (GMV)
Sven JANSEN (TNO)
Axel WION (VVA)
Armando LUCIANO (VVA)

Approved by: Martin SANCHEZ (GMV)

Authorized by: Ana GONZALEZ (GMV)

Code: D030
Issue: 2
Revision: 3
Date: 16/12/2022
Internal code: GMV 21005/22 V6/22

EXECUTIVE SUMMARY

During the development of ITHACA project, it was intended to take a glimpse on the future of autonomous transport industry and the role that GNSS will play in the integration of this technology. The project was led by GMV Aerospace and Defence S.A.U. acting as prime contractor for the EC and leader for a tendering organization that includes the following entities as subcontractors:

- **TNO** (Netherlands Organisation for Applied Scientific Research), from the Netherlands.
- **VVA** (VVA Brussels SPRL) from Belgium.
- **GMV-NLS** (Nottingham Scientific Ltd.), from the UK.

The main objective of the ITHACA project was to study whether an integrity service complementing European GNSS (EGNSS) High Accuracy Services would be beneficial for the market and its impact on the evolution and adoption of the solutions for the different transportation sectors.

Integrity for High Accuracy domain analysis and user needs

Several exploratory activities were performed in order to define the requirements foreseen for such Integrity Service.

- As a first and crucial step, user needs on accuracy and integrity were identified, by both reviewing state of the art performances as well as relevant regulations relevant to specific domains under study (Road, Maritime and Rail). Subsequently, identified prerequisites were validated by several experts from relevant domains.
- A thorough study on current standardization framework was as well carried out. This step was needed in order to understand and consider part of the system requirements.

Integrity Concept analysis

After this process, a strong interest in a future EGNSS based Integrity Service was identified among the Panel of experts created in the context of ITHACA Project. The integrity concept from the user point of view was subsequently analysed, from which a preliminary definition of service and sensor requirements was derived. This list of requirement provided a first view on the impact expected on current EGNOS and Galileo services, further developed during the Service definition. To finalize with the user analysis a dedicated test campaign was described.

Integrity model definition was performed starting from a functional design and then performing a HARA and FTA analysis. ITHACA service provides to this concept a reliable absolute positioning based on the computation of a Protection Level on top of a PPP High Accuracy solution, adding up contributions from:

- User environment and receiver measurements monitoring.
- Sensor fusion modelling and monitoring.
- Usage of integrity layer on top of received High Accuracy corrections.

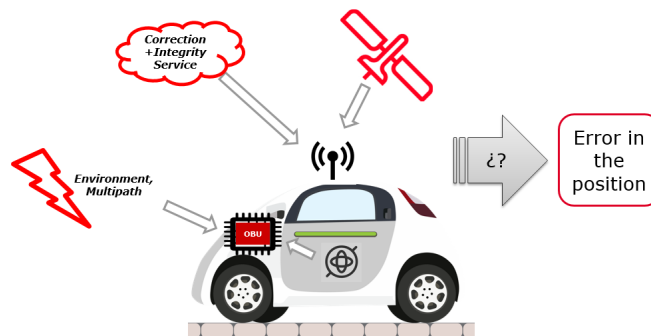

Figure 0-1. Representation of possible sources of error in absolute positioning

Target Integrity Risk allocation for the GNSS position is set to $1e-5/h$ to reach a global value of $1e-7/h$ with the full sensor fusion characterization. From this allocation, a total probability of error of $1.5e-6/h$ is considered responsibility of Ithaca Service. As part of the project, a suitable OBU architecture, compatible with the developed integrity concept is proposed (Figure 0-2).

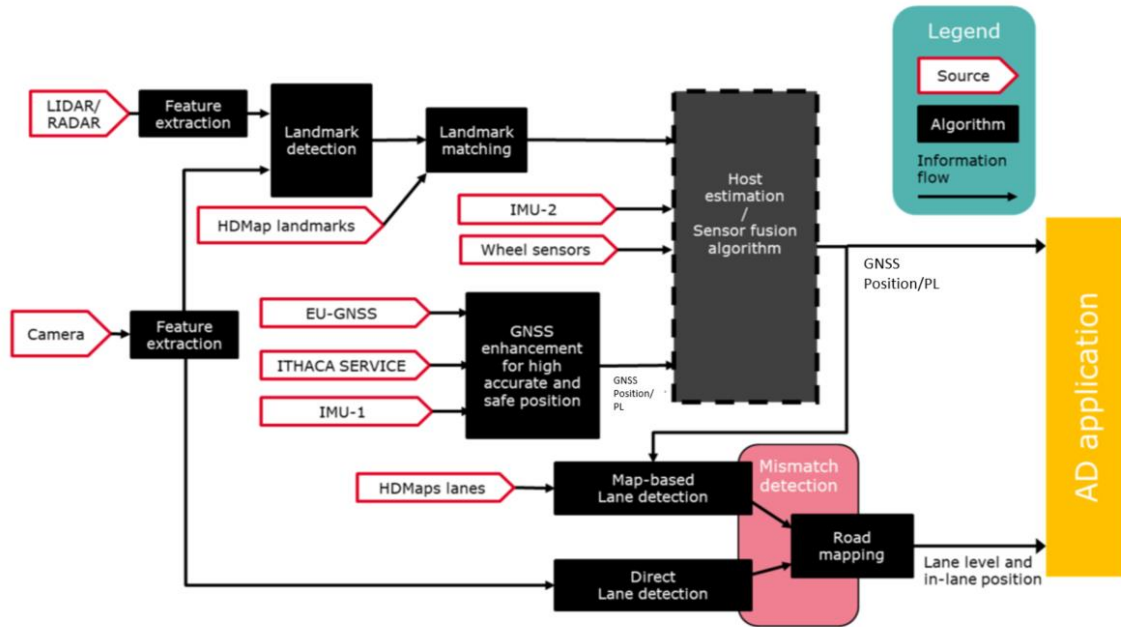

Figure 0-2: OBU architecture

One important conclusion obtained from this process is that user algorithm standardization is however considered as a key step to ensure Service Liability. Nevertheless, GNSS high accuracy algorithms are currently a field of active research, where tailored solutions are being defined for each particular application. Therefore, with the goal in mind to provide to the service enough flexibility to be widely accepted by the industry; at least, a minimum set of requirements can be set to the usage of integrity message in order to be able to apply some kind of liabilities, namely:

- 1) OBU Integrity concept adequately interprets the usage of the integrity message in the Protection Level
- 2) Risk allocation is compatible with message content

As a result of this integrity concept presented in additional requirements were derived. These requirements are set at very different levels such as:

- Supported constellations
- GNSS Sensor
- GNSS Antenna
- Network topology
- Security constraints
- Authentication needs
- Dissemination means
- Concept of operations

Subsequently, a multi-layered validation approach is proposed in order to perform a full test campaign. This approach involves validation of the OBU Integrity concept and the GNSS integrity

service separately, as well as so-called End-to-end validation of the combination. High level requirements to perform defined validation were provided.

E-GNSS Integrity Service definition

Proposed service consists on the addition of an integrity layer on top of the High accuracy corrections provided as evolutions of current Galileo and EGNOS services.

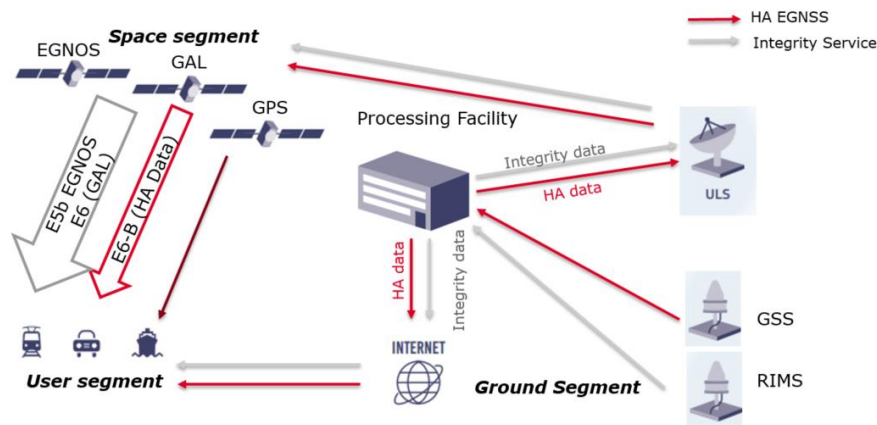

Figure 0-3. High Level architecture EGNSS+ Integrity Service

Main requirements fulfilled by the proposed system are presented in Table 0-1.

Table 0-1. Identified Service requirements

Requirement	Identified Needs
Supported Constellations	The user shall use corrections and integrity information for GPS and Galileo GNSS constellations
Supported Frequencies	Galileo: E1, E5a, E5b, E6 GPS: L1, L5
Protected GNSS corrections	The processing facility shall be able to generate integrity bounds related to corrections for satellite orbit, clock, code biases, phase biases, and ionospheric delay.
Global and Regional networks	EGNOS V3 RIMS and/or Galileo GSS shall be employed to generate and monitor the EGNSS data generation.
Dissemination through SIS	The SIS based dissemination channel shall be EGNOS E5B and Galileo E6B.
Ground based dissemination	The ground based dissemination channel shall be based on 5G.
Operations and Helpdesk	24x7 operations shall be available 8x5 helpdesk shall be provided.
Service availability	The overall monthly availability of the system shall be above 99.9%.

ITHACA Service Integrity concept presents a multi layered approach, considering two complementary concepts of "Online" and "Offline" integrity:

- Offline integrity is based on the analysis of the service history, obtaining an offline estimation of the service accuracy with respect to external reference products. This provides the user with a fair estimation on what error he can expect from the received corrections in their different components in nominal situations (orbit, clock, atmosphere effects, hardware biases)
- Online integrity is designed to deal with situations that seldom occur in reality (feared events) targeting integrity risks up to 1.5e-6/h in line with integrity analysis performed. This bound is based at real-time monitoring which aims to detect the errors introduced by the feared events and provide an upper bound of the non-detectable errors. This process is executed by continuously monitoring information to fulfil with very low Time to alert.

Usage of EGNSS infrastructure provides the remarkable opportunity to make available this message through several dissemination means which has several advantages:

- Firstly, if the user is able to receive the message from more than one source, it is likely that implementing the correct algorithm, it will be able to reconstruct the complete message without the need of waiting for a whole broadcast cycle to end.
- The usage of EGNOS GEO satellites ensures a good coverage in Europe and certain level of added redundancy over the whole service area
- As well, an extra layer of integrity is offered for the user, as this allows to compare and discard erroneous messages if discrepancies are detected.

Following the example in EGNOS for Aviation Users, it is key to establish certification processes for the EGNSS Integrity service specifically tailored for each specific sectors. An independent Authority should audit the terms of such certification, for which a Service Definition Document should be prepared in detail. ESA and EUSPA will not be held responsible or liable for any direct damage resulting of a misuse of the Service.

Decision criteria Analysis

A dedicated activity was endeavoured to quantify costs and benefits which might play a role in the decision process for the three main stakeholder groups involved: manufacturers, end users, and service providers. The analysis has stressed that manufacturers (i.e. OEMs) will most likely require to invest additional funding in each OBU to include the integrity concept, however these additional costs could be balanced by the fact that they will not have to pay a subscription fee to commercial service providers. Regarding end-users, the drivers, the outcome will most likely depend on how OEMs will pass on, or not, additional costs to end-users (or if they will find another way to balance the additional cost of the integrity concept – for example, savings on commercial subscriptions, exploitation of users data, etc.).

The analysis has also stressed that the decision criteria, in addition to the costs and potential benefits, will be impacted by other elements: the window of opportunity, and reliability of the system among others. It is expected by OEMs that if the integrity concept is not operational by then they will be strong commercial alternatives already implemented in their process for L5 vehicles. Another important element is the expected reliability of the system, OEMs will not risk their reputation, and thus their financial profitability, with a system which has not proven reliable enough compared to commercial alternatives.

As well, it is noted that similar approaches to what is presented in ITHACA project are being developed by private parties on the market, so it can be expected that relevant stakeholders from all studied sectors can access operational solutions that may suit their needs and specific requirements. It is therefore considered curtail for the success of such an initiative to clearly highlight potential benefits from such a public service (in terms of costs, liability, or solution trustworthiness)

This findings converge towards a clear window of opportunity (2025-2027), and late market availability would cause a transition from commercial providers to this service.

Service Roadmap activities

ITHACA aims at the Integrity Service provision with the goal to be adopted by wide autonomous transportation industries such as road, maritime or rail. In such a strategic sector in the years to come until the horizon 2030+, the success of the investment depends greatly on the acceptance of the integrity concept and subsequent demonstrations. The realization of such project involves important modifications to the current EGNSS infrastructure, which will have proportionate associated costs and need for investment. With these premises in mind, a series of Key Decision Milestones (KDM) have been defined aiming at mitigating the probability of this risk as much as possible.

These milestones have been identified at the end of each one of the development phases. They should really be understood as scheduled GO/NO GO evaluation processes in which a suitable board involving European Commission, EUSPA, Experts and other stakeholders analyse the outputs from the former phase and decide to continue with the next one.

Regarding the roadmap towards this solution, there are several dependencies that should be clarified and solved. In particular, one of the most relevant one relates to the available network including operational GSS and RIMS. During the service requirements analysis it is suggested that the network needs to be further densified in order to achieve accuracy commitments. This could be a critical point,

as some of the use cases (in particular for Road domain) may be jeopardized if convergence times are not reduced from current capabilities for HAS Level 1.

A growing trend on the use of HA and Safe positioning solutions it is currently observed with several OEM/Tier1 distributing RFI/RFPs with target dates for production around 2025-2027. The window of opportunity is clear, and later availability would cause a transition from commercial providers to this service, but the process will be for sure slower since the commercial services are typically contracted for 8-10 years periods.

As regarding EGNSS it is hard to define a realistic plan targeting an operational service in 2025, it is proposed to have as a goal to provide an entry level service for Automotive L3 in 2026-2027, targeting Automotive L4 and L5 in a longer timeframe (2030+).

DOCUMENT STATUS SHEET

Issue	Revision	Date	Pages	Changes
1	0	07/03/2022	11	First version Final Report, delivered for RM3 milestone
1	1	13/04/2022	52	<p>Version prepared for ITHACA RM3 CO</p> <p>Following answers to RIDs are implemented:</p> <ul style="list-style-type: none"> ■ ITHACA-RM3-RID-001: Grammar check executed in the document. ■ ITHACA-RM3-RID-002: Contractual documents removed ■ ITHACA-RM3-RID-003: Included list of acronyms in section 9.2 ■ ITHACA-RM3-RID-004: European commission disclaimer has been added to section 1.1 ■ ITHACA-RM3-RID-005: Sections 9.1 and 0 moved to the end of the document. ■ ITHACA-RM3-RID-006: Section 1.3 has been added in order to explain the context of the project as well as the logic of the work carried out during the project execution. Company logos involved in the consortium included. References to project documents have been removed, replacing them by references to the tasks described in the introduction. ■ ITHACA-RM3-RID-007: Section 9 Included to explain main challenges and main recommendations, future studies, key actions to take, main risks to manage, etc. Content will be provided in a future version of the document. ■ ITHACA-RM3-RID-008: Section included to present main conclusions of the project. Content will be provided in future version of the document. ■ ITHACA-RM3-RID-009: Document shows current conclusions of project status. This document will be updated as needed as the rest of the deliverables evolve. ■ ITHACA-RM3-RID-010: Links to other documents removed, instead the work is linked to the tasks defined. Content to all sections has been improved, by providing a better overview on tasks objectives and main conclusions ■ ITHACA-RM3-RID-011: Sections 3. , 4. , 5. , 6. Have been rewritten to provide harmonisation between the sections. Refer to answer for RID-010 ■ ITHACA-RM3-RID-012: Sentence with a typo has been removed after document update. ■ ITHACA-RM3-RID-013: Figures and tables relevant for the explanation of the project have been included throughout the document. ■ ITHACA-RM3-RID-014: Broken links fixed ■ ITHACA-RM3-RID-015: More information has been added to the report. Refer to answer for RID-010 ■ ITHACA-RM3-RID-181: Refer to implementation of RID-001
2	0	26/09/2022	65	<p>Version of the document prepared for the Final Review delivery.</p> <p>Following RIDs implemented:</p> <ul style="list-style-type: none"> ■ ITHACA-RM3-RID-003 and ITHACA-RM3-RID-005: Reference fixed in the changelog of document version 1.1 ■ ITHACA-RM3-RID-006: Several sentences rephrased throughout the document
2	1	18/11/2022	55	<p>Version of the document prepared for the Final Review CO delivery. Following RIDs have been addressed:</p> <ul style="list-style-type: none"> ■ ITHACA-FR-RID-001: As it has been agreed, track changes will be maintained until the last version of the document to ease revision. ■ ITHACA-FR-RID-002: Executive summary added to the document

Issue	Revision	Date	Pages	Changes
				<ul style="list-style-type: none"> ■ ITHACA-FR-RID-003: Grammar check performed in complete document. ■ ITHACA-FR-RID-004: Added list of experts in Table 1-1 ■ ITHACA-FR-RID-005: Figure quality has been improved. ■ ITHACA-FR-RID-006: Synthetic description of standards included in Table 3-1 ■ ITHACA-FR-RID-007: Figure updated, using "source" instead of "sensor" ■ ITHACA-FR-RID-008: Clarification has been included in document [D210]. Table removed from Final Report. ■ ITHACA-FR-RID-009: Clarification of required frequencies included section 4.2 ■ ITHACA-FR-RID-010: Description added in D210 and reference added in Table 4-4. ■ ITHACA-FR-RID-011: Description added in D210 and clarification added in Section 4.1.4 . ■ ITHACA-FR-RID-012: Added statement regarding the window of opportunity for the service in section 7. ■ ITHACA-FR-RID-013: Added explanation to ease interpretation to roadmap in section 7. ■ ITHACA-FR-RID-014: See answer to ITHACA-FR-RID-002 ■ ITHACA-FR-RID-015: See answer to ITHACA-FR-RID-001 ■ ITHACA-FR-RID-016: GSA updated with EUSPA. ■ ITHACA-FR-RID-017: Typos corrected ■ ITHACA-FR-RID-018: Typo corrected ■ ITHACA-FR-RID-019: Typo removed after document rework ■ ITHACA-FR-RID-020: Service liabilities included in section 5.4, EGNSS data message described in Table 5-2, EGNSS requirements described in Table 4-4, conclusions on the roadmap, risks and impact in critical path included in 7. , receiver algorithm included in Table 4-3 ■ ITHACA-FR-RID-021: Typo corrected ■ ITHACA-FR-RID-022: Typo corrected in 3.2.3 ■ ITHACA-FR-RID-023: Typo corrected ■ ITHACA-FR-RID-024: Section modified to improve clarity ■ ITHACA-FR-RID-025: Corrected typo in image ■ ITHACA-FR-RID-026: Checked references to documents across the report ■ ITHACA-FR-RID-027: Sentence removed as a result of document review ■ ITHACA-FR-RID-028: Typo corrected ■ ITHACA-FR-RID-029: Table removed as a result of document review (refer to ITHACA-FR-RID-008) ■ ITHACA-FR-RID-030: Paragraph rephrased ■ ITHACA-FR-RID-031: Typo corrected ■ ITHACA-FR-RID-032: Typos corrected in Figure 4-5 ■ ITHACA-FR-RID-033: GPS constellation added in Figure 5-1. Added table with constellations and frequencies supported to section 5. ■ ITHACA-FR-RID-084: Answered for ITHACA-FR-RID-016 ■ ITHACA-FR-RID-085: Answered for ITHACA-FR-RID-002 ■ ITHACA-FR-RID-086: Final summary has been restructured to reduce total length, adding main conclusions and removing introductions or procedures to obtain results, which can be consulted in dedicated documentation. ■ ITHACA-FR-RID-087: Sentences regarding performed activities through the document have been rephrased ■ ITHACA-FR-RID-088: TTA comment corrected in 3.2.1 ■ ITHACA-FR-RID-089: "ITHACA" acronym harmonised throughout the document.

Issue	Revision	Date	Pages	Changes
				<ul style="list-style-type: none"> ■ ITHACA-FR-RID-090: Problem identified regarding section hierarchy. However, section has been removed upon document restructure. ■ ITHACA-FR-RID-091: Proposal for operations and helpdesk exploitation has been simplified has been removed upon document restructure. ■ ITHACA-FR-RID-092: Explanation removed from FR, added to document [D240] ■ ITHACA-FR-RID-093: Explanation removed from FR, added to document [D240] ■ ITHACA-FR-RID-094: Explanation removed from FR, added to document [D240] ■ ITHACA-FR-RID-095: Galileo HAS Service Level instead of "Phase" is referred to in section 5.1 ■ ITHACA-FR-RID-096: Map of proposed global and regional networks has been included in section 5.1 ■ ITHACA-FR-RID-097: Trade-off analysis regarding bandwidth usage due to integrity message included in document [D310] ■ ITHACA-FR-RID-098: References to EGNOS and Galileo programmes updated throughout the document ■ ITHACA-FR-RID-099: Added to section 6. ■ ITHACA-FR-RID-100: Added to section 6. ■ ITHACA-FR-RID-101: Rephrased sentence regarding project focus in 7. ■ ITHACA-FR-RID-102: Questions regarding the timeline have been addressed in section 7. And document [D510]. Justification for authentication needs included in Final Report ■ ITHACA-FR-RID-103: Refer to answer to ITHACA-FR-RID-003 ■ ITHACA-FR-RID-104: Liability considerations have been added in section 5.3 ■ ITHACA-FR-RID-105: Application of Final Report RIDs have been crosschecked throughout all project deliverables
2	2	12/12/2022	54	<p>Version of the document prepared for the Final Review Delta CO delivery. Following RIDs have been addressed:</p> <ul style="list-style-type: none"> ■ ITHACA-FR-RID-014: Typos correction, added proposed OBU architecture, main service requirements and latest updates (regarding expected window of opportunity) in Executive summary. ■ ITHACA-FR-RID-017: Sentence rephrased in section 2.2. Added additional information about the host estimation algorithm in section 4.1.2 (As well as document D210) ■ ITHACA-FR-RID-020: Several improvements applied to overall document. ■ ITHACA-FR-RID-023: "the user algorithm is depicted", section 4.1.1
2	3	16/12/2022	55	<ul style="list-style-type: none"> ■ ITHACA-FR-RID-017: additional information added in in section 4.1.2 ■ ITHACA-FR-RID-070: Added information about certification working group in section 5.4 ■ ITHACA-FR-RID-082: 5G roadmap added to Figure 7-1

TABLE OF CONTENTS

1.	INTRODUCTION	14
1.1.	PURPOSE	14
1.2.	DOCUMENT STRUCTURE	14
1.3.	STRUCTURE OF WORK	14
1.3.1.	Consortium	14
1.3.2.	Project Activities	15
1.3.3.	Expert Consultation	16
2.	ITHACA PROJECT CONTEXT	18
2.1.	PROJECT OVERVIEW AND CONTEXT	18
2.2.	ITHACA PROTECTION LEVEL	18
3.	INTEGRITY CONCEPT FOR EGNSS HIGH ACCURACY DOMAIN ANALYSIS AND USER NEEDS.....	19
3.1.	STANDARIZATION FRAMEWORK.....	19
3.2.	USER NEEDS	19
3.2.1.	Road	19
3.2.2.	Rail	21
3.2.3.	Maritime	22
4.	INTEGRITY MODEL DEFINITION	23
4.1.	USER INTEGRITY CONCEPT ANALYSIS	23
4.1.1.	Target Integrity Risk	23
4.1.2.	System Architecture	23
4.1.3.	Hazard Analysis and Risk Assessment (HARA).....	24
4.1.4.	Fault Tree Analysis (FTA)	25
4.1.5.	GNSS Positioning Algorithm.....	27
4.2.	EGNSS SERVICE REQUIREMENTS	28
4.3.	TEST CAMPAIGN REQUIREMENTS.....	30
4.3.1.	Multi Layered validation approach	30
4.3.2.	Test Campaign	31
5.	EGNSS INTEGRITY SERVICE DEFINITION	33
5.1.	SERVICE DEFINITION	33
5.1.1.	Station Network evolution	34
5.1.2.	Integrity Service concept	36
5.1.3.	Dissemination means	37
5.1.4.	Data Authentacion	37
5.2.	CONCEPT OF OPERATIONS	38
5.3.	REGULATORY CONSIDERATIONS.....	38
5.4.	SERVICE LIABILITY	39
6.	DECISION CRITERIA ANALYSIS FOR THE ROAD SECTOR.....	41
7.	SERVICE ROADMAP ACTIVITIES	43
8.	RECOMMENDATIONS FOR FUTURE WORK.....	49

9. DOCUMENTS AND ACRONYMS 50
9.1. REFERENCE DOCUMENTS 50
9.2. ACRONYMS AND DEFINITIONS 50

LIST OF TABLES AND FIGURES

Table 0-1. Identified Service requirements	4
Table 1-1. Delphi Panel of experts	16
Table 3-1. Summary of road sector standardization	19
Table 3-2: Automotive use cases and related requirements	19
Table 3-3: Selected railway applications with relevant description and classification	21
Table 3-4: Use Cases for the rail sector and corresponding requirements	21
Table 3-5: Minimum maritime user requirements for general navigation	22
Table 4-1: Hazards with ASIL rating	25
Table 4-2: Appointed ASIL values from FTA	25
Table 4-3. GNSS Positioning Algorithm	27
Table 4-4. Identified Service requirements	28
Table 4-5: Test campaign requirements	31
Table 5-1. Proposed additional Global and Regional stations	34
Table 5-2. Offline/Online integrity overview	36
Table 6-1: Risk analysis for OEMs.....	41
Table 7-1. Ithaca Key Decision Milestones	43
Table 7-2: Risk assessment matrix	44
Table 7-3. ITHACA project Risk Matrix	46
Table 9-1 – List of deliverables for ITHACA project.	50
Table 9-2 – List of reference documents.....	50
Table 9-3: Acronyms	50
Figure 0-1. Representation of possible sources of error in absolute positioning.....	2
Figure 0-2: OBU architecture	3
Figure 0-3. High Level architecture EGNSS+ Integrity Service.....	4
Figure 1-1: Overview of ITHACA consortium.	15
Figure 1-2: Proposed DELPHI methodology.....	17
Figure 2-1. Representation of possible sources of error in absolute positioning.....	18
Figure 3-1: EU27 + Norway + Switzerland + Iceland	20
Figure 4-1: ITHACA high level integrity concept	23
Figure 4-2: OBU architecture	24
Figure 4-3: Top event initial allocation	26
Figure 4-4: Faulty branch risk allocation.....	27
Figure 4-5: Multi-Layered Validation Approach	30
Figure 5-1. High Level architecture HAS + Integrity Service.....	33
Figure 5-2. Processing Facility high level architecture.....	34
Figure 5-3. Simulated DOC from Galileo GSS proposed enhancement	35
Figure 5-4. Proposed EGNOS RIMS extension with 250km baseline.....	36
Figure 5-5. EGNSS Infrastructure	38

Figure 5-6. Main actors identified for ITHACA Service provision 39
Figure 7-1. ITHACA service proposed roadmap overview 48

1. INTRODUCTION

1.1. PURPOSE

This document is ITHACA Final Report - Project Executive Summary. It includes a summary of the results achieved in the project.

The project results represent the views of the users and the consortium. They do not necessarily represent the views of the European Commission and they do not commit the Commission to implementing the results.

Present document version has been prepared for the Final Review close out data package.

1.2. DOCUMENT STRUCTURE

This document is structured as follows:

- Chapter 1 introduces the purpose and organisation of this document.
- Chapter 2 provides an introduction and high level overview of ITHACA project, explaining the context, goals and structure of the work.
- Chapter 3 presents the results of the Integrity for EGNSS high accuracy domain analysis and user needs.
- Chapter 4 defines the User integrity concept of the project, as well as the identified mission requirements, user receiver model and test campaign approach.
- Chapter 5 presents the integrity service complementing EGNSS high accuracy definition.
- Chapter 6 contains the decision criteria analysis for the road sector.
- Chapter 7 contains ITHACA roadmap activities.
- Chapter 8 summarizes the main conclusions of the project.
- Chapter 9 explains the main challenges and main recommendations identified during the project development, future studies, and key actions to take, main risks to manage, etc.
- Chapter 10 includes the list of referenced documents, acronyms and definitions used throughout the document.

1.3. STRUCTURE OF WORK

1.3.1. CONSORTIUM

The ITHACA project was led by GMV Aerospace and Defence S.A.U. acting as prime and sole contractor for the EC. GMV acted as leader for a tendering organization (herein referred to as "the consortium") that includes the following entities as subcontractors:

- **TNO** (Netherlands Organisation for Applied Scientific Research), from the Netherlands.
- **VVA** (VVA Brussels SPRL) from Belgium.
- **GMV-NLS** (Nottingham Scientific Ltd.), from the UK.

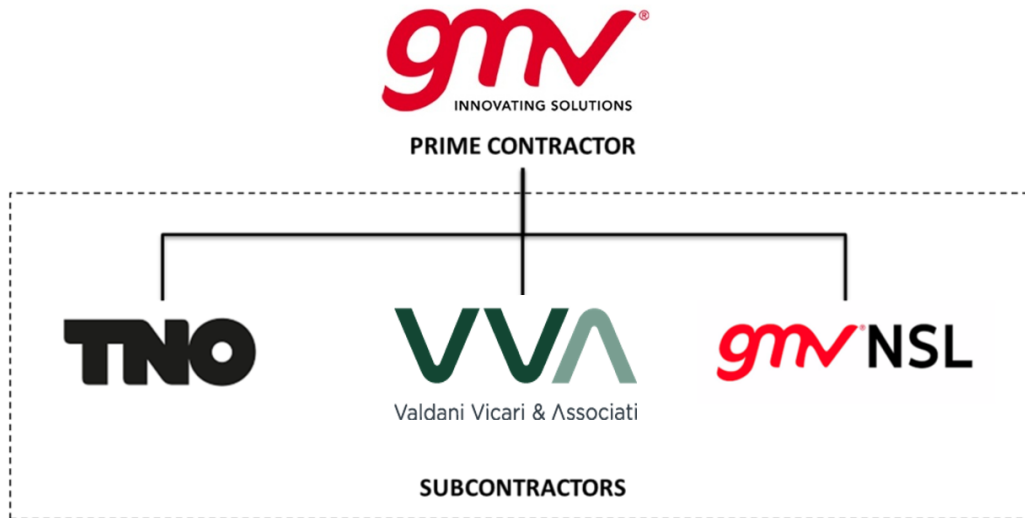

Figure 1-1: Overview of ITHACA consortium.

The key features of the consortium are the following:

- **GMV** provides background in relevant domains such as the development of GNSS High accuracy solutions for different customers and markets (such as AALECS, Galileo Commercial service and HADG, Galileo High Accuracy Data Generator) for the EUSPA. Additionally, GMV is the provider of high accuracy services for a number of customers in several markets including the transmission for HA corrections through SBAS (SPADANZ project for Australia and New Zealand).
- **TNO** offers to the project experience in the development of a complete solution for autonomous driving, including innovative concepts for positioning, as well as testing and validation autonomous driving systems for car manufacturers. As well, the company has experience conducting safety assessment for road applications, including specific safety assessment of solutions for ADAS and autonomous driving.
- **VVA** brings to the consortium its experience in areas such as setting up and managing experts' panels and conducting Cost Benefit Analyses in the frame of multiple GNSS related projects and studies.
- **GMV-NLS** provides key experience in developing and performing research on innovative GNSS applications for multiple domains, including the rail and maritime sectors.

1.3.2. PROJECT ACTIVITIES

Project activities are divided into 5 main groups also called "Tasks". These are briefly described hereinafter:

- Task-1: Integrity for High Accuracy Domain Analysis and User Needs

This task analysed the road sector domain, including the relevant terminology and key stakeholders of the value chain involved in the provision of integrity services for high accuracy applications. Special attention is dedicated to the standardization framework. Afterwards user needs in the road sector and their potential evolution were analysed including requirements for additional dissemination means other than existing EGNSS systems. Main conclusions from this work are summarized in document section 3.

- Task-2: Integrity Concept Analysis

This task defined the concept of integrity of the OBU. Several activities were undertaken to contribute to the task final goal.

First, the integrity model was defined for level 5 autonomous vehicles in the road sector. Several technological approaches were proposed and a trade-off process was followed, together with expert consultation in order to provide a general overview. Then, other sensors and requirements for GNSS receivers were identified and analysed. Also as part of this task, the basic requirements for an OBU

validation campaign were identified. Main conclusions from this work are summarized in document section 4.

■ Task-3: Service definition

During the development of this activity, the characteristics of the integrity service complementing EGNSS high accuracy were defined. This definition also includes the concept of operations description, and the draft of a system compliant with the requirements identified. From the user point of view, hybridization technique allowing the performance required for the operation was described. Main conclusions from this work are summarized in document section 5.

■ Task-4: Decision Criteria Analysis in the Road sector

This activity determined the decision criteria for the different decision makers’ point of view (e.g. vehicle and device manufacturers), looking at advantages they gain in adopting EGNSS versus alternative options. The main goal of the task is to identify the key decision criteria for each stakeholder that motivates their decision to provided or adopt the proposed service and to understand the implementation costs upon the service adoption by users. Main conclusions from this work are summarized in document section 6.

■ Task-5: Roadmap implementation

Finally, during this activity the next activities that shall be carried out to go ahead with the service implementation were identified. This analysis tackles the activities to be performed, as well as key decisions to be taken. Main conclusions from this work are summarized in document section 7.

1.3.3. EXPERT CONSULTATION

A panel of experts was set at the beginning of Task 1 execution with relevant stakeholders to road, maritime and rail markets, which agreed to validate the key outputs throughout the whole project. Configuration of final panel is shown in Table 1-1. The panel of experts was consulted in several occasions throughout the project to refine the understanding of current and future user needs with relation to positioning integrity, to validate relevant road sector terminology and the go/no-go decision criteria for the adoption of an integrity service complementing EGNSS high accuracy by relevant players in the value chain. The panel of experts also provided contribution to the validation of the Integrity model inputs, EGNSS and other components; definition of the test campaign; decision criteria that may motivate the adoption of the proposed service, regarding the identified costs and/or risks and roadmap activities.

Table 1-1. Delphi Panel of experts.

Sector		
Road	Vehicle Manufacturer	GM
Road	Service provider	NavCert
Road	Vehicle Manufacturer	Renault
Road	Vehicle Manufacturer	Volvo Cars
Road	Components and receiver manufacturer	Hexagon
Road	Component manufacturer	i2cat
Road	Trade Association	ACEA
Road	Map provider	TomTom
Road	Tier 1 supplier	Bosch
Road	Vehicle manufacturer	Volkswagen Group Innovation
Road	Vehicle manufacturer	FCA/CRF (Stellantis)
Maritime	Transport expert/pilot	Marine Synergy
Maritime	Transport expert	Puertos de Sevilla
Maritime	Maritime expert	The General Lighthouse authorities (GLA) of the UK and Ireland
Rail	Component Manufacturer	Hitachi Rail STS
Rail	Manufacturer	CAF
Rail	Manufacturer	CEIT

Three Delphi interview rounds were carried out to achieve the abovementioned objectives:

- Delphi Round #1: Was conducted in order to obtain a critical analysis of the road domain and user needs with the aim to present to the stakeholders the findings of our work and to gather feedback and validation
- Delphi Round #2: Presentation of the integrity model and service definition. Additionally, some extra stakeholders from maritime and rail domain were engaged to validate the identified user needs
- Delphi Round #3: Validation of the findings of the overall study

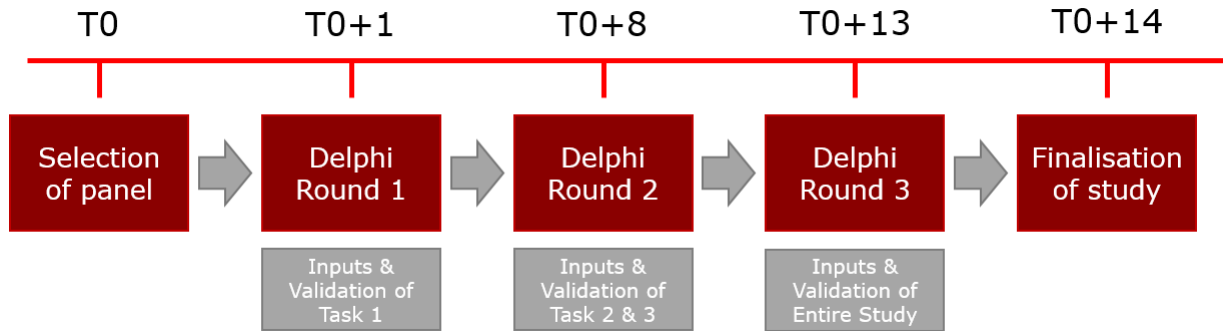

Figure 1-2: Proposed DELPHI methodology

2. ITHACA PROJECT CONTEXT

2.1. PROJECT OVERVIEW AND CONTEXT

The increased interest in the autonomous transportation technologies, in which accuracy position estimation and integrity play a key role, has opened a wide range of opportunities for European GNSS systems. Autonomous transport is expected to reduce human-based errors, improving also the efficiency of certain operations. This efficiency improvement will occur provided that the autonomous operations are performed under (at least) the same safety conditions as the current ones.

Main objective of the ITHACA project is to study whether an integrity service complementing European GNSS (EGNSS) High Accuracy Services would be beneficial for the market and its impact on the evolution and adoption of the solutions for the different transportation sectors.

2.2. ITHACA PROTECTION LEVEL

ITHACA integrity concept is based on the computation of a GNSS based position Protection Level (PL). This value shall cover the errors due to a limited set of sources that have an impact in the user solution. For the GNSS based positioning, these error sources are shown in Figure 2-1.

- The first error source is the stream of measurements obtained from the signal tracking through the receiver. An integrity model in charge of managing these kind of errors was developed as part of the project scope and is presented in section 4.
- The second possible source of error is the Navigation and Correction message received from the signal in space. ITHACA service must aim at reducing the probability of such errors to an acceptable limit (refer to section 5.)
- Accurate physical models are needed at the user level to correctly reconstruct these measurements identifying the different components and sources of error in observation measurements. It is possible to justify the confidence of these models by their extensive usage and acceptance by GNSS community, so that the expected error contribution can be assumed to be small.
- Last source of errors include all the additional contributions from external sensors used from the car. This risk must be handled under the user monitoring capabilities.

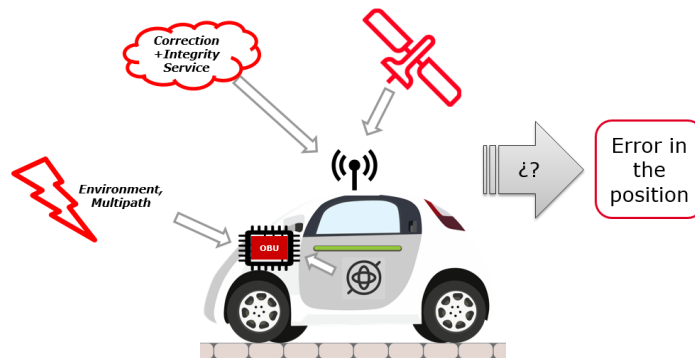

Figure 2-1. Representation of possible sources of error in absolute positioning

The Protection Level computation must represent a conservative estimation of the errors coming from these sources (in particular, failure modes detected from the GNSS measurements and the used IMU-1 in Figure 4-2 to hybridize GNSS solution as well as the information provided by the Integrity service) and provide a model of how these errors propagate to the position solution errors.

3. INTEGRITY CONCEPT FOR EGNSS HIGH ACCURACY DOMAIN ANALYSIS AND USER NEEDS

3.1. STANDARIZATION FRAMEWORK

A thorough analysis of current and foreseen market status, as well as current standardisation frame was performed by ITHACA consortium. It was concluded that the automotive standards are converging to aviation-like approach through the SOTIF [RD.1]. The most quoted standard by the panel of experts is the ISO26262 [RD.2], which is aligned with the desk research analysis. The current process of ensuring this is based on the Functional Safety (FuSa) policies of ISO26262:2018 [RD.2].

The functional safety (FuSa,) and safety of the intended functionality (SOTIF) are two of the pillars for a safe location module. Both functional safety and SOTIF are ruled by ISO26262 [RD.2] and ISO 21448, [RD.1] and are tackling different safety aspects. These two standards are complemented with the ISO 21434, [RD.3] which defines the policies to rule the security and cyber-security processes needed for connected vehicles.

Since GNSS components are part of ADAS (and ADS), aspects related to GNSS shall be also considered and tackled as a hazard, where security is an additional aspect compared to environmental disturbances. For an Integrity GNSS High-Accuracy Positioning solution, the three standards are relevant and shall be applied to the different elements of the chain. Hence, both the equivalent to the Ground Segment Correction Service and User Segment shall be developed according to the proposed standard, or others which can be considered compatible.

Table 3-1. Summary of road sector standardization

Regulation	Scope	Status
ISO 26262	Functional Safety (FuSA) intends to ensure safety in the case of component failure.	Published 2018-12
ISO 21448	Safety of the intended functionality (SOTIF). This regulation intends to complement the work done on the functional safety layer, tackling at situations that may occur, with special focus in the unsafe and unknown cases outside the ODD, rather and focusing at a HW/SW malfunction.	Published 2022-06
ISO 21434	Cyber security processes needed for connected vehicles	Published 2021-08

3.2. USER NEEDS

3.2.1. ROAD

The typical use cases of GNSS in Autonomous Driving include lane identification, path planning, geo fencing, platooning and autopilot. While GNSS requirements in support of these applications already exist, the assumption was that additional or revisited GNSS localization system requirements from OEMs may arise for the 2025-2035 timeframe as long as GNSS is used in support of higher levels of automation.

In order to generate an accurate baseline for user requirements, a series of interviews regarding relevant stakeholders in Delphi panels were carried out. The subsequent needs consolidation provided Table 3-2 as a result. It is noted that requirements have been defined specifically for typical use cases.

Table 3-2: Automotive use cases and related requirements

Use Case/ Applications	Accuracy	Availability	Continuity Risk	Integrity Risk	TTA	Alert Limit
Autonomous Emergency Braking with visual impairment	1m	>99.9%	1E-5/hour	1E-7/hour	100ms	3.5m

Use Case/ Applications	Accuracy	Availability	Continuity Risk	Integrity Risk	TTA	Alert Limit
Crossroad passing	0.2m	>99.9%	1E-5/hour	1E-7/hour	36ms	0.7m
Crossroad passing with visual impairment	0.2m	>99.9%	1E-5/hour	1E-7/hour	36ms	0.7m
Active Lane Control with visual impairment	0.2m	>99.9%	1E-5/hour	1E-7/hour	36ms	0.7m
Turn with visual impairment	0.2m	>99.9%	1E-5/hour	1E-7/hour	50ms	0.7m
Trajectory Prediction	1m (long. and 0.5 lat.)	>99.9%	1E-5/hour	1E-7/hour	100ms	3.5m
Lane Change Assist with visual impairment	0.2m	>99.9%	1E-5/hour	1E-7/hour	21ms	0.7m
Multi-Layer Bridge/Streets [H]	H: 0.2m	>99.9%	1E-5/hour	1E-7/hour	21ms	H: 0.7m
Multi-Layer Bridge/Streets [V]	V: 1m	>99.9%	1E-5/hour	1E-7/hour	21ms	V: 3.5m
Lane identification	0.2m	>99.9%	1E-5/hour	1E-7/hour	21ms	0.7m
Path Planning	0.2m	>99.9%	1E-5/hour	1E-7/hour	100ms	3.5m
Geo fencing	10m	>99.9%	1E-5/hour	1E-7/hour	10s	35m
Platooning	0.2m	>99.9%	1E-5/hour	1E-7/hour	50ms	0.7m
Autopilot (cruise control)	0.2m	99.7%-99.9%	1E-5/hour	1E-7/hour	-	-

Target service area was also defined within the scope of this consultation. In the context of this project, the target service area considered is EU27 plus Norway, Switzerland and Iceland region.

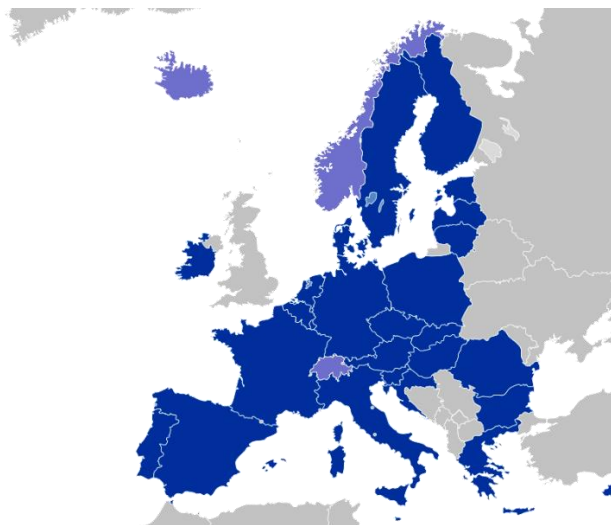

Figure 3-1: EU27 + Norway + Switzerland + Iceland

3.2.2. RAIL

For the railway sector, main stakeholders agree on the relevant impact that autonomous driving will have on the sector in the future by reducing operational costs and improving the service to the passengers. Autonomous driving is considered a must for the future, and effort is going towards the achievement of level 2 automation in the next future; and towards achieving level 4 in the next years.

Table 3-3 provides an overview on the relevant rail safety applications, and Table 3-4 shows identified related requirements.

Table 3-3: Selected railway applications with relevant description and classification

Use Case/ Applications	Description	Classification
Cold Movement Detection	A cold movement detection (CMD) system requires GNSS or other means to detect the train movements while the equipment is not powered up. The CMD function compare train positions when entering and exiting of non-power or it detects train movement during the non-power mode, depending on if the Location Unit is dependent of the train power or not.	Safety Application, ATP
Track Selectivity (or Track identification)	A track identification system requires GNSS and other track based infrastructure information to determine the current track on which the train is running.	Safety Application, ATP
Door Control Supervision with Automatic Train Operation (ATO)	The purpose of this application is to enable the opening of specific doors at particular stations. GNSS would be used to locate the train within a station.	Safety Application, ATP
Odometer calibration	The odometer is used for speed, distance, acceleration and running direction measurements by measuring the train's movement along the track. Odometer accuracy is compromised by wheel slips due to rain, ice, snow, and leaves. Independent positioning can be used to calibrate the train odometer for systematic biases that have been introduced through operation. GNSS could be used to assist in the calibration of the train's odometer.	Non-Safety Application, liability relevant
Infrastructure/Gauging Surveying	Mobile surveying systems combining GNSS and other technologies (i.e. images, video etc.) have been developed to collect data on the railway infrastructure. This allow the monitoring of the asset without requiring access to or near the line. The gauging survey represents a subsystem of infrastructure surveying, but with more stringent Integrity requirement. Its aim is to provide high precision positioning information to the gauging surveys which ensure that a particular rail vehicle can transit in a particular part of the network without incidents.	Non-Safety Application, liability relevant

Table 3-4: Use Cases for the rail sector and corresponding requirements

Use Case/ Applications	Accuracy	Availability	Safety application	Integrity Risk	TTA	Safety Integrity Level
Cold Movement Detection	< 1m	99.99% Urban canyon Canopy Indoors	YES	E-9/hour	< 10s	4
Track Selectivity	< 1.9m (2D)	99.99% Urban canyon Canopy Indoors	YES	E-9/hour	10s – 30s	4
Door Control Supervision with ATO	~ 1m (2D)	>99%	YES	E-9/hour	10s – 30s	4
Odometer calibration	< 1km/h (2D)	100% counting on other sensor fusion	YES	E-9/hour	< 10s	4
Infrastructure/Gauging Surveying	0.01 – 1m	Low	NO	N/A	~ 30s	N/A

3.2.3.MARITIME

Having in mind the objective to show the GNSS requirements at user level, in Table 3-5 are shown the minimum maritime user requirements for general navigation taking into account different navigation phases according to IMO resolution A.915(22) [RD.6]. This table has been updated after Delphi Round #2, with the stakeholders participating in the second round of the expert’s panel. Some of the requirements have also been updated according to [RD.7] and [RD.8].

Table 3-5: Minimum maritime user requirements for general navigation

	System level parameters				Service level parameters			
	Absolute Accuracy	Integrity			Availability % per 30 days	Continuity % over 3 hours	Coverage	Fix interval ² (seconds)
	Horizontal (metres)	Alert limit (metres)	Time alarm ² to (seconds)	Integrity risk (per 3 hours)				
Ocean	10	25	10	10 ⁻⁵	99.8	N/A ¹	Global	1
Coastal	10	25	10	10 ⁻⁵	99.8	N/A ¹	Global	1
Port approach	1	25	10	10 ⁻⁵	99.8	99.97	Regional	1
Restricted waters	5	12.5	10	10 ⁻⁵	99.8	99.97	Regional	1
Port	1	2.5	10	10 ⁻⁵	99.8	99.97	Local	1
Inland waterways	3	7.5	10	10 ⁻⁵	99.8	99.97	Regional	1

Note: 1: Continuity is not relevant to ocean and coastal navigation

2: More stringent requirements may be necessary for ships operating above 30 knots.

4. INTEGRITY MODEL DEFINITION

According to the identified interest in a future EGNSS based Integrity Service was identified among the Panel of experts created in the context of ITHACA Project. An OBU integrity concept was derived during Task 2, targeting at analysing some of the use cases for which GNSS endeavours a greater impact in the overall safety functionality. As a result of such analysis, several additional requirements were identified for the Service and the user equipment needed. Finally, a dedicated test campaign to cover main integrity requirements was proposed.

4.1. USER INTEGRITY CONCEPT ANALYSIS

4.1.1. TARGET INTEGRITY RISK

Integrity can be defined as a measure of the trust that can be placed in the correctness of the information supplied by the total positioning system. It is considered from the end-user solution point of view and takes into account all elements of the architecture considered in the architecture definition. TIR requirements are expressed as the maximum acceptable probability of system integrity failure. The Target Integrity Risk (TIR) requirements are defined in Table 3-2 depending on the use case. The whole positioning system has to comply with the most restrictive TIR requirements of all of them, which is 1E-7 per h.

Since the non-GNSS sensors used for autonomous driving are currently evolving, the sensors that will be used for SAE Level 5 autonomous cars are not in the market yet, so it is not possible to know in advance which failure rates they will have or which TIR values they will be able to achieve. For this reason it was decided to be more lenient with the relative positioning subsystem and stricter with the GNSS subsystem, which we are confident that it can achieve 1e-5 per h. This means that the overall TIR can be broken down and allocated to the two systems:

- The relative positioning system (non-GNSS) was be allocated 1E-2 per h.
- The absolute positioning system (GNSS) was be allocated 1E-5 per h.

4.1.2. SYSTEM ARCHITECTURE

The overall ITHACA concept of the user algorithm is depicted in Figure 4-1 and it concerns the operation of different external services. These services are based on the evolution of current EGNSS High accuracy messages, adding an additional integrity layer (provided by "ITHACA service"). Both sources of information allow the computation of absolute GNSS positioning enhancement and Protection Level estimation ensuring the positioning error up to an allocated Target Integrity Risk.

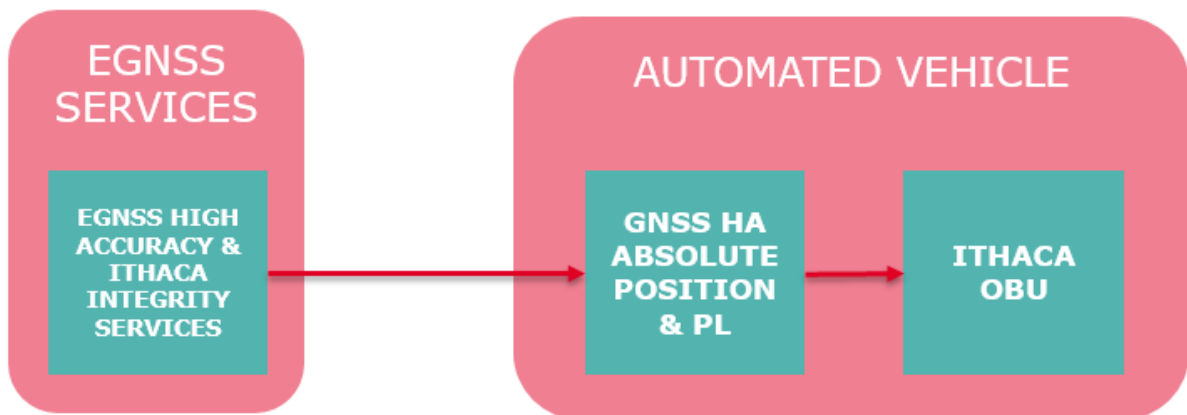

Figure 4-1: ITHACA high level integrity concept

This section focusses on the integrity analyses of the systems on the Automated Vehicle, and specifically the OBU configuration depicted in Figure 4-2 where it can be seen that the enhanced GNSS and Protection Level are used for the so-called host estimation. The host estimation utilizes various

sensors and GNSS to estimate the absolute position of the vehicle, which then is combined with HD maps to estimate the position of the vehicle on the road and in the lane.

Different methods can be used for the mismatch detection which typically contain sensor models that allow identification of deviations considering the specific failures or signal deviations that can occur based on the sensing principles. These detections can consider the environmental effects (allowing for a model based method such as a Kalman Filter), fault mode effects where specific sensor faults are modelled, and other (proprietary) methods. The Vehicle State Estimator is typically a combination of a physics based method and logic based method where specific fault conditions are handled. Targeted performance requirements are described in Table 3-2.

The Protection Level is used within the host estimation to assess how much the enhanced GNSS can be relied upon. For a large Protection Level, the GNSS is inaccurate and may not be used, however for a small Protection Level it can improve the integrity of the host estimation. Final protection level shall at least account for the following error contributions (as introduced in section 2.2):

- Measurement errors tracked by GNSS receiver, mitigated by user integrity monitors
- Error in High accuracy corrections, mitigated by Integrity service error bounding.
- Additional contributions from internal sensors used for positioning solution (IMU-1)

The ITHACA project research considers Autonomous Driving applications that are strongly making use of Global Navigation Satellite System (GNSS) information obtained by the vehicle. This includes a few future/fictive applications, not currently available or existing summarized in Table 3-2. In order to reach depth in the analysis two applications proposed applications which best represent the positioning challenges for the future (Active Lane Control and Crossroads Passing with visual impairment). Several sensors are considered relevant for the proposed design, fulfilling the needs for the most challenging cases, namely: Cameras, LIDAR, HD Maps and GNSS, V2X Communication, GNSS Receiver model, Health Monitor.

Figure 4-2 depicts the functional diagram of the OBU related to host estimation and road mapping.

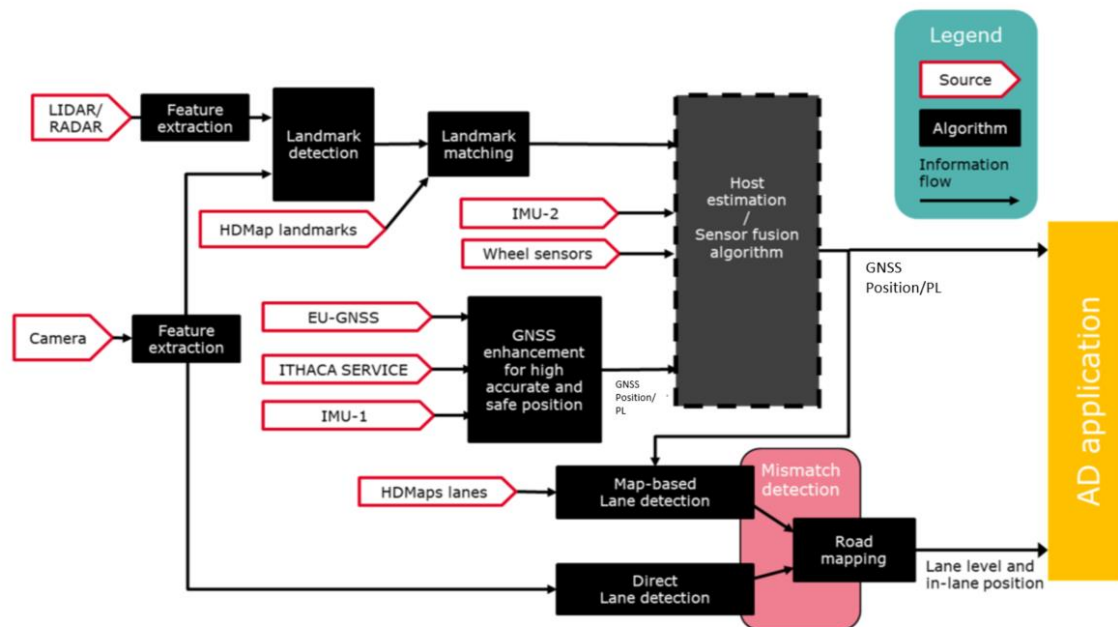

Figure 4-2: OBU architecture

4.1.3. HAZARD ANALYSIS AND RISK ASSESSMENT (HARA)

Based on the presented architecture, the following step is to perform a Hazards and Risk Analysis (HARA) in which all the possible Hazards derived from the presented architecture are provided ASIL ratings, and further decomposed if this is allowed by the process. The resulting Hazards and ASIL

values are shown in Table 4-1. Due to the fact that an L5 application is being analysed, many hazards will have a low controllability score and therefore a high ASIL rating.

Table 4-1: Hazards with ASIL rating

ID	Top Level Hazards	ASIL
HZ_01	Excessive or unwanted acceleration	D
HZ_03	Insufficient or no motor power / acceleration.	QM
HZ_05	Unintended drive off from stationary	C
HZ_06	Roll-away of vehicle on slope	QM
HZ_07	Excessive or unintended braking	D
HZ_08	Insufficient or no braking	D
HZ_10	Excessive or unintended steering	D
HZ_11	Steering in wrong direction	D
HZ_12	Insufficient or no steering (with no response to driver hand wheel input)	D
HZ_21	System does not go to standby and does not hand over control to the driver when the driver requests to take control.	A
HZ_15	Vehicle performs automated lane change beyond prescribed lateral limits of the target lane	C
HZ_16	Vehicle performs partial automated lane change	D
HZ_17	Vehicle performs automated lane change in opposite lane to that required	D
HZ_18	Automated lane change of vehicle into occupied lane	D

4.1.4. FAULT TREE ANALYSIS (FTA)

In the FTA, the above mentioned hazards are analysed. In a nutshell, the FTA identifies the faults in the system that can lead to the negative consequences of the hazards shown above. GNSS is deemed as a reliable positioning sensor in the application, so its failure will affect the vehicles positioning in many of the failure paths of the FTA.

So ASIL decomposition is applied, as ASIL-D rating is very stringent and difficult to achieve for a sensor. According to ISO 26262, an ASIL D functionality can be decomposed into two redundant ASIL B (D) functionalities if the absence of common cause failures can be ensured. Following situations have been separately analysed, regardless of their possible mitigations which could solve the issues by design.

Table 4-2: Appointed ASIL values from FTA

High level basic event name	Appointed ASIL
GNSS fails	ASIL-B(D)
GNSS is too inaccurate	ASIL-B(D)
GNSS sensor position calibration has offset	ASIL-B(D)
GNSS not available	ASIL-B(D)

It shall be noted that the event "GNSS fails" is a High level event that refers to a misleading output of the GNSS module, without going into details of the cause. A description of all these events can be found in Table 6-2 of the D210.

The FTA provides a useful means to allocate the Target Integrity Risk (TIR) values to lower-level system components such as subsystems and integrity monitors. The integrity failure event (which occurs when the actual position error exceeds the calculated PL without alerting it in the safety qualifier), also referred to as loss of integrity, is therefore the top integrity event to be considered in the Fault Tree Analysis.

The FTA methodology is very well suited and is widely used in GNSS systems to further decompose the top-level TIR requirements into lower level allocations to the main system components contributing to safety.

The proposed integrity concept for the GNSS subsystem considers that it can be in any of the following states:

- **Fault-free state:** In this state, the system is working nominally in the absence of failure modes.
- **Faulty State:** In this state, the system is affected by at least one failure mode that may cause an error in the position, velocity and track angle estimations.

The GNSS FTA is fully consistent with the integrity concept, and consequently the top event (loss of integrity) is broken down into two main branches:

- **Fault Free Branch:** This branch of the FTA includes the events that may lead to a loss of integrity under fault-free conditions. The FTA allocates 25% of the TIR to the fault-free state.
- **Faulty Branch:** This branch of the FTA further decomposes the events that may lead to a loss of integrity under failure conditions. The FTA allocates 75% of the TIR to the faulty state, which is further decomposed in lower-level allocations for each individual failure mode identified in the safety analyses.

With that background in mind, it is decided to assign more budget to the Faulty branch because of the number of failure modes that needed to be covered by the faulty case.

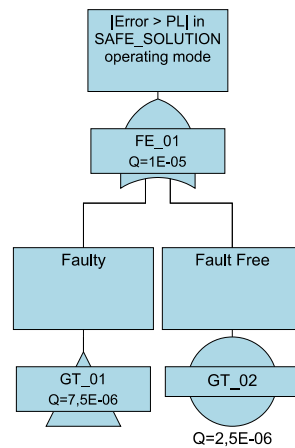

Figure 4-3: Top event initial allocation

Identified failure modes that can contribute to a loss of integrity if undetected are shown in but they will not contribute to increasing the Protection Level. Instead, if one of the Failure Modes is detected, the affected measurements will be discarded and the position/velocity will be computed using the remaining measurements. A Protection Level will only be computed when there are no Failure Modes that affect the computed solution.

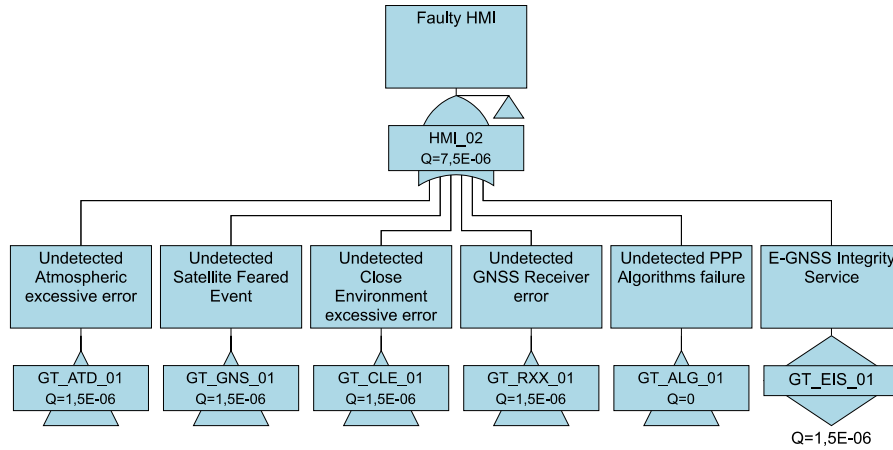

Figure 4-4: Faulty branch risk allocation

4.1.5. GNSS POSITIONING ALGORITHM

GNSS positioning is described with the following design decisions which are considered intended to meet user requirements for an absolute, precise and safe position.

Table 4-3. GNSS Positioning Algorithm

GNSS Algorithm	Design Choice	Rationale	Related Requirement
GNSS Constellations	GPS + Galileo	Satellite availability is considered optimal using both constellations. User is expected to use corrections and integrity information related to GPS and Galileo.	Accuracy
Frequency processing	Dual Frequency Algorithm	Single frequency algorithms do not provide enough level of accuracy. Iono-free combinations are required to mitigate atmospheric errors in the solution. However, Ithaca concept leaves some flexibility towards the pairs of frequencies to be implemented in the algorithm (as long as they are supported by the correction and integrity services). This is considered more a cost-driven decision than a technical one.	Accuracy
Position algorithm	Kalman Filter	Target user represents a dynamic system subject to noise measurement. Recursive nature of the filter helps to estimate the propagation of each variable learning from system accuracy of the previous computational step.	Accuracy
Sensor hybridization	Tightly coupling IMU	The absolute positioning system computes the position using the GNSS and IMU in a tightly coupled system and the velocity in a separate filter using only GNSS measurements. This not only can improve the GNSS only solution, but helps bridging GNSS outages during Dead Reckoning navigation.	Continuity Risk Availability

GNSS Algorithm	Design Choice	Rationale	Related Requirement
Environment monitoring	System health monitor	<ul style="list-style-type: none"> System monitors must be continuously reviewing system status so safety mitigation can be instigated if a fault is detected. In particular, specific monitors to detect faulty situations in GNSS measurements are the most restrictive ones. 	TTA
Protection Level Computation	GNSS Protection level is computed from user level monitors and Integrity Service information	<p>Protection level is computed using two different sources of information:</p> <ul style="list-style-type: none"> First one is the observation at user level of the measurement quality and observables that can provide information (for example, high multipath, IMU/GNSS inconsistency, etc). Here, if a faulty situation is detected, no solution is computed and therefore, no PL is computed either. If no faulty situation is detected, an integrity bound is computed by each of the safety monitors. Second one is to compute the problems that can be found inherently through satellite signal processing, that might not be evident for the user (for example high ionospheric activity). This is where the integrity service shall provide the added value: it has the capability of implementing different kinds of monitoring and detect failures or hazardous situations using data from a dense station network and then send alarms (in case of a faulty situation) or integrity bounds to the user. If no faulty situation has been detected neither at user level nor by the service, the PL is computed taking into account all the integrity bounds of the safety monitors and the integrity service. 	Integrity Risk

4.2. EGNSS SERVICE REQUIREMENTS

As a result of the integrity concept presented in 4.1, additional requirements from the Receiver, Antenna and Service point of view have been derived.

Main ones, which will be taken into consideration for the Service definition are summarized in Table 4-4.

Table 4-4. Identified Service requirements

Group	Requirement	Identified Needs
Functional	Supported Constellations	The user shall use corrections and integrity information for GPS and Galileo GNSS constellations
Functional	Supported Frequencies	Galileo: E1, E5a, E5b, E6 GPS: L1, L5
Functional	Protected GNSS corrections	The processing facility shall be able to generate integrity bounds related to corrections for satellite orbit, clock, code biases, phase biases, and ionospheric delay.
Stations	Global and Regional networks	EGNOS V3 RIMS and/or Galileo GSS shall be employed to generate and monitor the EGNSS data generation.
Stations	Depth of Coverage	Global Sensor Stations shall provide a Depth of Coverage (Contributing States) of at least 4 in the service area. DOC 3 is required for the rest of the globe.
Stations	Separation of Regional Stations	Regional stations shall be separated a maximum of 250 km distance between them.

Group	Requirement	Identified Needs
Integrity	Probability of Failure	The processing facility probability of failure shall be 1.5e-6/h
Integrity	Failure modes detected by Integrity Service	The E-GNSS service shall be able to detect the following Failure modes: <ul style="list-style-type: none"> ■ "Ionospheric large gradient" with a PMD of 1E-05. ■ "Inter-frequency phase bias instability" with a PMD of 1E-05. ■ "Inter-frequency group delay instability" with a PMD of 1E-05. ■ "Clock instabilities" with a PMD of 1E-05. ■ "Signal distortion" with a PMD of 1E-05.
Dissemination means	Dissemination through SIS	The SIS based dissemination channel shall be EGNOS E5B and Galileo E6B.
Dissemination means	Ground based dissemination	The ground based dissemination channel shall be based on 5G.
Dissemination means	Common ICD	The EGNSS service ICD shall be common to all dissemination channels.
Concept of Operations	Operations and Helpdesk	24x7 operations shall be available 8x5 helpdesk shall be provided.
Concept of Operations	Service availability	The overall monthly availability of the system shall be above 99.9%.
Security	End to End protection	The transmission of the EGNSS data shall be protected during the whole transmission chain with appropriate means to allow authentication, ensure data integrity and non-repudiation.
Authentication	Authentication needs	Authentication shall be needed for every batch of data to be used. This includes GPS and Galileo navigation data, and EGNSS correction and Integrity messages.
GNSS Sensor	Supported measurement channels	Receiver shall process measurements from following frequencies Galileo: E1, E5a, E5b, E6 GPS: L1, L5
GNSS Sensor	Supported data channels	The GNSS sensor shall support one or more of the following dissemination means: <ol style="list-style-type: none"> 1) Tracking and demodulation of Galileo E6 data component 2) Tracking and demodulation of EGNOS E5b data component 3) Support of ground base dissemination channels, by the reception and decoding of Internet based corrections through 5G
GNSS Sensor	Freedom from interference	"Freedom of interference" due to external inputs or QM dependencies shall be considered/justified as part of the safety process.
GNSS Sensor	Safety Manual	Safety Manual with the relevant information to configure and operate in safe conditions shall be provided by the manufacturer.
GNSS Sensor	Antenna Monitoring	Antenna status shall be monitored considering at least: <ul style="list-style-type: none"> ■ Power consumption is in the range of the specification SNR values received are within expected range considering the antenna gain specified.
GNSS Sensor	Jamming detection/mitigation	The GNSS sensor shall implement interference detection based on signal processing indicators (e.g.: Automatic Gain Control, RF indicators...) The GNSS sensor shall implement countermeasures against jamming and non-intentional interference (e.g. notch filter, pulse blanker, etc.). More detail on the different types of RFI can be found in D210 Section 7.3.10.

Group	Requirement	Identified Needs
GNSS Sensor	Spoofing detection	The GNSS sensor shall implement spoofing detection based on signal processing and navigation information (e.g.: observer satellite behaviour versus expected position, AGC and C/N0 checks,)
GNSS Antenna	Active antenna	The antenna shall be active.
GNSS Antenna	Supported frequencies	The antenna shall support the following frequencies: Galileo: E1, E5a, E5b, E6b GPS: L1, L5
GNSS Antenna	Wireless connectivity	The antenna shall allow wireless connectivity to vehicle-to-vehicle (V2X) services.

4.3. TEST CAMPAIGN REQUIREMENTS

4.3.1. MULTI LAYERED VALIDATION APPROACH

As shown in Figure 4-5 a multi-layered validation approach is proposed in order to perform a full test campaign. This approach involves validation of the OBU Integrity concept and the GNSS integrity service separately, as well as so-called End-to-end validation of the combination.

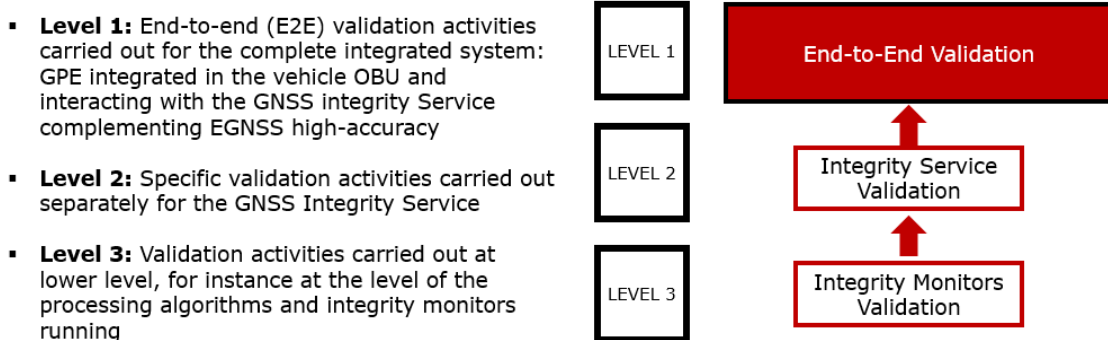

Figure 4-5: Multi-Layered Validation Approach

The proposed approach for validating an OBU Integrity Concept is to gather fault-free data from driving tests of relevant use cases, and artificially introduce faults to validate the integrity mechanisms in the OBU, as well as to assess how positioning is affected by different sensor or GNSS faults. The approach is to have driving tests and static tests in the service area and around the outskirts of the service area. The driving tests should be executed under a wide variety of geo-physical conditions. Static tests should be aimed on long-term monitoring (e.g., 12 months) of the GNSS Integrity Service while registering weather conditions. The static locations should be selected based on different climatic conditions to ensure that the service is validated for a wide variety of weather conditions.

The driving tests for validation of the GNSS Integrity Service should involve data collection for validation of the OBU Integrity Concept as well in order to validate the combination with the GNSS Integrity service. Two main aspects should be analysed

- OBU Integrity Concept:
 - Derive the relevant failure (or fault) conditions for the developed OBU integrity concept
 - Relate the failure conditions to driving scenarios, considering relevant use cases
 - Define the signals required for obtaining the OBU generated position and the reference (ground truth) position
 - Execute driving tests for use cases under fault-free conditions, with a vehicle equipped with target sensors for the OBU and a reference positioning system
 - Introduce faults by modification of recorded signals, or using signals generated by simulation
 - Assess how the OBU integrity concepts functions in response to injected faults by Sill or Hill methods
- GNSS Integrity service
 - Derive the relevant environmental conditions for the defined GNSS Integrity service
 - Define the additional signals (i.e. compared to OBU Integrity concept validation) required to categorize specific environmental conditions
 - Execute validation tests for the relevant environmental conditions, with an equipped vehicle and static setups
 - Relate test results to categorized environmental conditions
 - Assess expected GNSS performance using the GNSS Integrity service for combinations of categorized environments

4.3.2. TEST CAMPAIGN

The integrated test campaign is based on the test campaign for the OBU integrity concept and the test campaign for the GNSS Integrity Service. Requirements on equipment, data extraction and test procedures for the integrated test campaign were analysed and declared. A summary is provided in Table 4-5.

Table 4-5: Test campaign requirements

Activity	Description
Required Stakeholders	<ul style="list-style-type: none"> ■ Vehicle testing: Vehicle testing organisation, Vehicle OEM or 1st tier, GNSS system supplier ■ Fault injection test cases: Sensor supplier, GNSS component supplier, GNSS service supplier ■ Conditions monitoring: Local (road) authorities, Weather agencies, RTK service suppliers ■ Analyses and Evaluation: vehicle testing organisation, OBU system provider, Vehicle OEM or 1st tier supplier, GNSS component supplier, GNSS service supplier
Scenarios and duration of each test	<ul style="list-style-type: none"> ■ Proving ground driving tests: 1 week for full protocol ■ Public road driving tests: The public road driving tests should be executed on test routes around locations with specific geo-physical conditions. Each test route should be driven in three repetitions (for assurance of having representative results) ■ Long term static tests: It is recommended that these test should be done for a period of 12 month or more.

Activity	Description
Use cases	<ul style="list-style-type: none"> ■ Crossroad passing ■ Crossroad passing with visual impairment ■ Active Lane Control with visual impairment ■ Turn with visual impairment ■ Trajectory Prediction ■ Lane Change Assist with visual impairment ■ Multi-Layer Bridge/Streets [H] ■ Multi-Layer Bridge/Streets [V]
Parameters to be measured/basic metrics	<p>The parameters that need to be measured are input and output signals of the on-board GNSS equipment and OBU integrity concept respectively. Secondly reference signals need to be measured in order to judge the performance of the positioning concepts. Specifically for public road tests, the vehicle needs to be equipped with sensors that can assess the weather conditions, while a camera system is required to register the geo-physical conditions.</p>
Representativeness of the results	<p>Test are generally repeated at least three times to ensure that measurement faults can be detected and incorrect data can be excluded. The proposed method addresses individual phenomena, which typically occur in a combination during normal driving. By collecting data from connecting roads between test locations (under the normal variety of conditions), it can be validated (at least in case an RTK service is available) that the results from individual tests will be representative.</p>

5. EGNSS INTEGRITY SERVICE DEFINITION

This section includes the proposal of an integrity service complementing Galileo HAS providing an overview on the needs for the ground, space and user segments. Former analysis performed regarding the user requirements and OBU integrity concept, as well as the expected impact on EGNOS and Galileo are considered.

The usage of augmentation information and Integrity information offered by systems such as EGNOS has been widely accepted in Aviation applications. However, it is clear that the complete concept of providing Integrity information through the signal in space has a clear limitation when it is intended to expand its usage to road, rail or maritime domains; as the typical use cases cover a much wider variety of users in more challenging, less controlled scenarios. This is why a narrow collaboration between a potential service integrity information and the user capability of analysing and reacting to the local effects of the environment is mandatory.

5.1. SERVICE DEFINITION

Proposed service is based on the provision of an Integrity layer on top of the precise corrections generated by evolutions of E-GNSS high accuracy services under the assumption that requirements identified for the high accuracy generation of phase bias and Ionospheric corrections shall be compatible with the identified user needs. A preliminary analysis of the service requirements has been identified in, where it has been found that user requirements fulfilment must rely on the combination of two groups of messages made available to the user:

- High Accuracy GNSS Corrections, which will be provided by evolutions of existing EGNSS in the frame of the (Galileo HAS service and EGNOS evolutions) in two phases.
 - Service Level #1 will provide Global orbit, clock, code bias and phase bias correction
 - Service Level #2 will provide local Ionosphere bias corrections
- Integrity message, providing information about the over bounding error of High accuracy corrections.

Integrity layer is added on top of the High accuracy corrections, and make use of equivalent dissemination means.

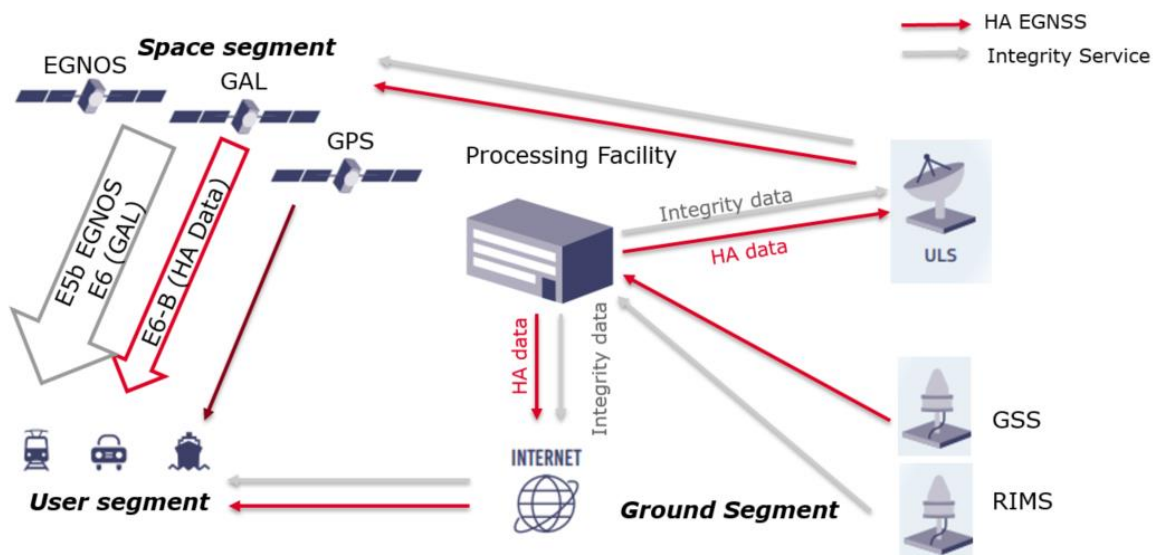

Figure 5-1. High Level architecture HAS + Integrity Service

As seen in the figure, many synergies can be used from current E-GNSS architecture. GPS is also accounted as a key part of the integrity service. Figure 5-3 shows the proposed high level architecture of the Integrity Processing facility

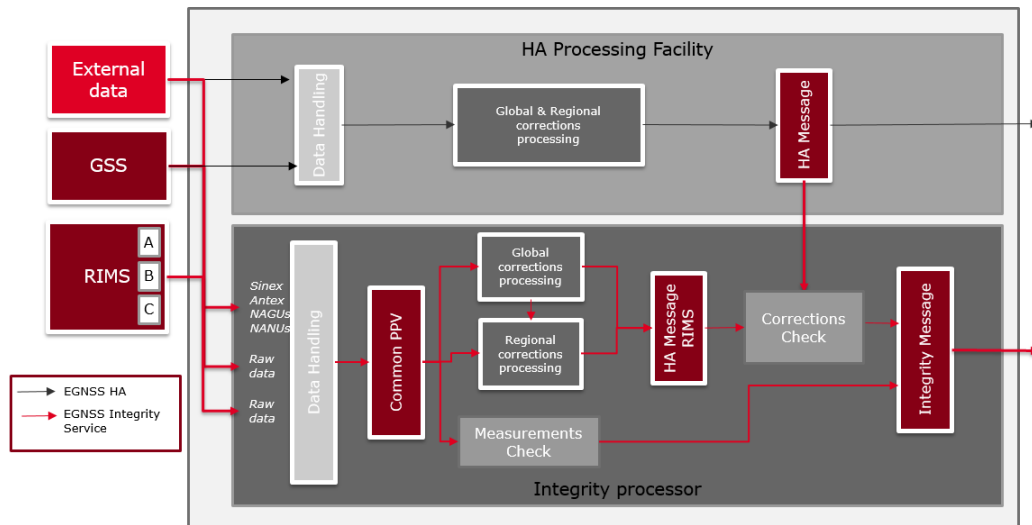

Figure 5-2. Processing Facility high level architecture

5.1.1. STATION NETWORK EVOLUTION

Regarding the Ground segment, the need for an upgrade and extension of current GSS/RIMS network has been identified. Following table show the summary of additional stations proposed to expand the network to fulfill service and user requirements.

Table 5-1. Proposed additional Global and Regional stations

Country	Network	Location	Coverage area
USA	Global	Hawaii	Improve coverage in the Pacific area
Chile	Global	Isla de Pascua	Improve coverage in the Pacific area
French Polynesia	Global	Papeete	Improve coverage in the Pacific area
South Africa	Global	Cape Town	Improve coverage Indic Ocean
Indonesia	Global	Kuala Lumpur	Improve coverage Indic Ocean
Spain	Regional	Albacete	Mainland Spain
Spain	Regional	Valladolid	Mainland Spain
France	Regional	Grenoble	Mainland France
France	Regional	Nantes	Mainland France
Italy	Regional	Milan	Alps area
Italy	Regional	Lecce	South of Italic peninsula and part of Greece
Italy	Regional	Alghero	Mediterranean Islands (Corsica and Sardinia)
Germany	Regional	Köln	BeneLux
Germany	Regional	Nuremberg	Mainland Germany
Croatia	Regional	Dubrovnik	Croatia and part of the Balkans
Slovenia	Regional	Grad	Border of Slovenia, Hungary and Austria
Czech Republic	Regional	Ostrava	Czech Republic and part of Romania
Romania	Regional	Cluj-Napoca	High percentage of the Romania's territory
Norway	Regional	Oslo	Mainland Norway
Norway	Regional	Bodo	Mainland Norway
Sweedeen	Regional	Skelleftea	Bothnia Gulf.
Sweedeen	Regional	Kuusamo	Sweden and Finland
Latvia	Regional	Riga	Estonia Latvia and Lithuania

Two main reasons justify the deployment of additional deployment RIMS and GSS stations.

- The GSS network shall fulfill the role of global network and provides raw data to generate global corrections and integrity information. It is proposed to reinforce the coverage on several areas (mainly in the Pacific Ocean), in order to ensure a global DOC of 3. Figure 5-3 shows the overall DOC of the current GSS network, including 5 additional GSS locations (signaled with a yellow triangle).

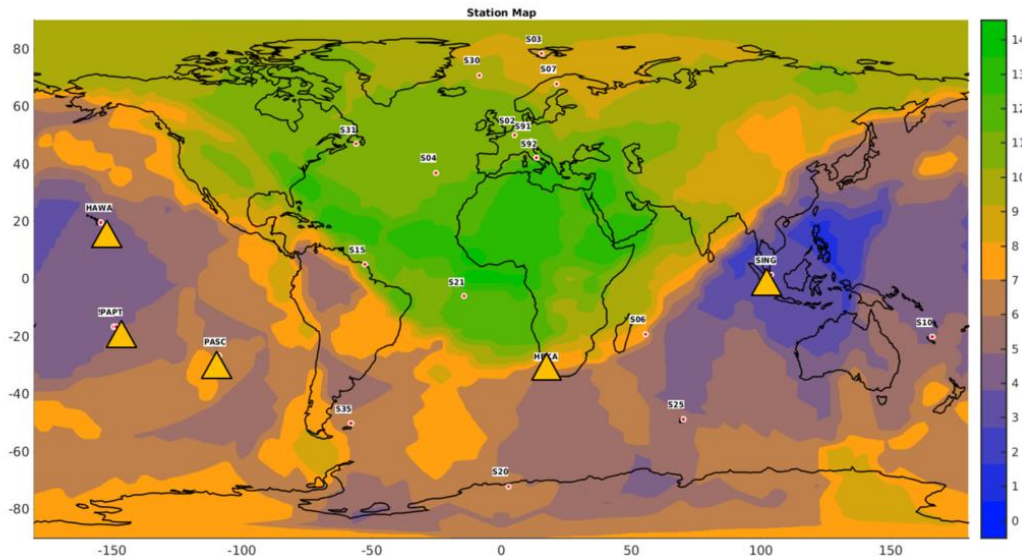

Figure 5-3. Simulated DOC from Galileo GSS proposed enhancement

- In the case of the RIMs, which will be used as regional network, with the main objective of computing high accuracy ionospheric corrections the main driver is to reduce the maximum distance between adjacent stations. Requirement of a maximum baseline of 250km has been identified during task 2, necessary to ensure the usage of nearby (<125 km) regional corrections for high accuracy user. Figure 5-4 show network topology proposed (in yellow) on top of existing RIMs network (red).

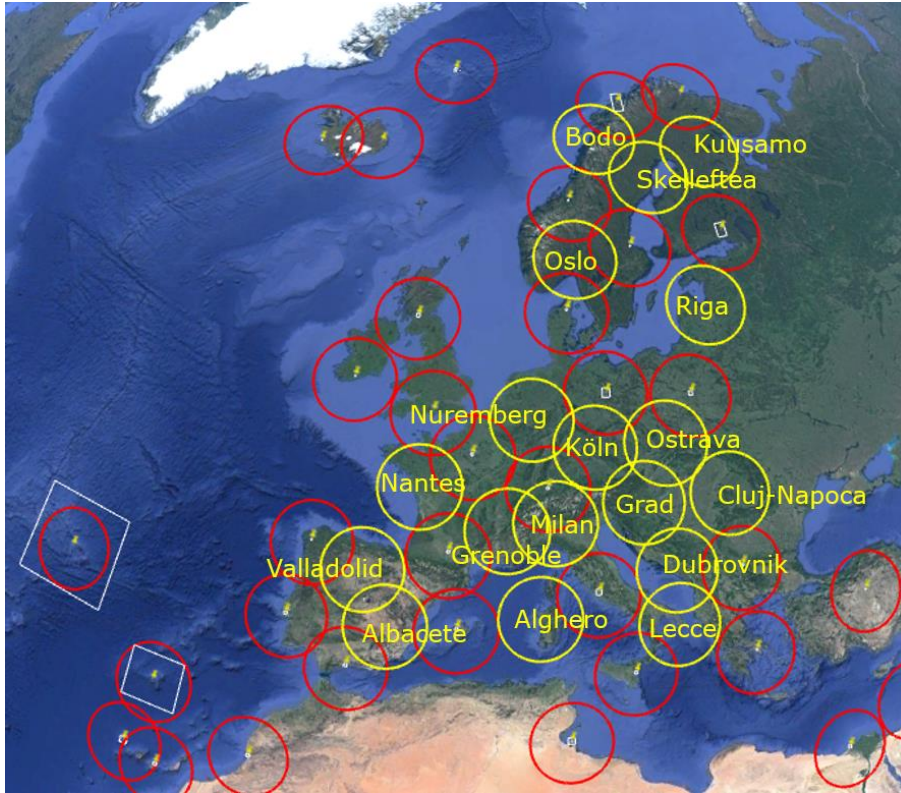

Figure 5-4. Proposed EGNOS RIMS extension with 250km baseline

5.1.2. INTEGRITY SERVICE CONCEPT

ITHACA Service Integrity concept presents a multi layered approach, considering two complementary concepts of “Online” and “Offline” integrity:

- Offline integrity is based on the analysis of the service history, obtaining an offline estimation of the service accuracy with respect to external reference products. This type of assessment might deal with an integrity risk of the order of 10^{-4} or $10^{-5}/h$ (events happening once every 1 to 10 years), but there is not strong commitment regarding the time to alert. This provides the user with a fair estimation on what error he can expect from the received corrections in their different components in nominal situations (orbit, clock, atmosphere effects, hardware biases)
- Online integrity is designed to deal with situations that seldom occur in reality (feared events) targeting integrity risks up to $10^{-7}/h$ in line with the needs identified from consulted stakeholders. This bound is based at real-time monitoring which aims to detect the errors introduced by the feared events and provide an upper bound of the non-detectable errors. This process is executed by continuously monitoring information to fulfil with very low Time to alert.

Table 5-2. Offline/Online integrity overview

	Offline Integrity	Online Integrity
Definition	Probability distribution of a particular range error contribution in the fault free state	Upper bound of the maximum range domain error that may not have been detected by the system for error contribution t in line of sight i : $u_{i,t}$
Affected corrections	Orbit, Clock, Iono, HW bias	Orbit, Clock, Iono, HW bias
Covered Target Integrity Risk	Up to $10^{-4}/h$	Up to $1.5 \cdot 10^{-6}/h$

	Offline Integrity	Online Integrity
Model	<p>Error is modelled as a nominal bias plus a Gaussian zero centred noise distribution</p> $E_{t,i} = \mu_{t,i} + v_{t,i}$ <p>Over bounded distribution is provided by:</p> <ul style="list-style-type: none"> Bound to the nominal bias, where $\mu_{t,i} \leq b_{t,i}$ Gaussian over bound of zero mean noise for which $v_{t,i} < N(0, \sigma_{t,i})$ 	<p>Maximum probability for a failure mode to go undetected for a longer time than the required time to alert must follow this equation:</p> $P[E_{t,i} \geq u_{t,i} \text{fault } t,i] \leq p_{md,t,i}$ <p>Online integrity acts by lowering the probability that the user employs data with errors greater than $u_{t,i}$ meters by means of detecting them and alarming the user accordingly.</p>
Message content	<ul style="list-style-type: none"> Over bounded bias $b_{t,i}$ for each correction Sigma for the zero mean noise $\sigma_{t,i}$ Flags that indicates if the information is usable or not 	<ul style="list-style-type: none"> Upper bound error per line of sight and correction $u_{t,i}$ meters for a defined probability of missed detection. This upper bound can be provided for one or more $p_{md,t,i}$ Flags indicating if the information is usable or not
Computation method	<p>Assessment on the error distribution for each one of the corrections is performed by comparison of past correction messages with consolidated reference data, provided by external sources.</p>	<p>Online monitors are defined to detect the allocated failure modes, and estimating the range-domain errors in real time. When an error is larger than the monitor threshold is detected:</p> <ul style="list-style-type: none"> Activates "invalid" flags or, Raises upper bound $u_{t,i}$ meters
Latency	~days	Update of integrity message (~seconds)
External dependencies	<p>Reliable reference data</p> <p>Data sources for each one of the provided corrections.</p>	<p>Bounds and probabilities are based in real time monitoring</p>

5.1.3. DISSEMINATION MEANS

Usage of EGNSS infrastructure provides the remarkable opportunity to make available this message through several dissemination means. On the one hand, it is proposed to disseminate the integrity message through the Signal in Space through Galileo E6 and EGNOS E5b. Additionally, it is proposed to use ground dissemination means to distribute both High accuracy corrections and integrity message through internet. This diversification is found to present several advantages:

- Firstly, if the user is able to receive the message from more than one source, it is likely that implementing the correct algorithm, it will be able to reconstruct the complete message without the need of waiting for a whole broadcast cycle to end.
- The usage of EGNOS GEO satellites ensures a good coverage in Europe and certain level of added redundancy over the whole service area
- An extra layer of integrity is offered for the user, as this allows to compare and discard erroneous messages if discrepancies are detected.

5.1.4. DATA AUTHENTICACION

Data authentication shall be applied to the data-components where the EGNSS data is being disseminated (E6B, E5b or ground channels). For SIS-based channels the NMA-like implementations should be considered, some projects have been awarded by the European Commission to analyse this approach. This feature consists of digitally signing the integrity message through the dissemination signals. Then, the receiver should be able to demodulate the received data with a public key to check the authenticity of the transmitted key. Then, it uses the transmitted key and the digital signature to check the authenticity of the navigation data. This feature allows to identify the signal of a satellite as spoofed, and therefore providing the user with the possibility to exclude it from the computation.

5.2. CONCEPT OF OPERATIONS

EGNSS shall be deployed in dedicated sites coping with security and redundancy requirements. A minimum of 4 instances in permanent operation, located in two different sites. An additional chain for training and maintenance operations is also previewed.

The most appropriate approach is to use the existing locations of Galileo or EGNOS to deploy the new elements and create the necessary secured communication links between the previous services (e.g.: diodes in communications) to ensure that the new data flows and services do not impact the operation of the existing ones.

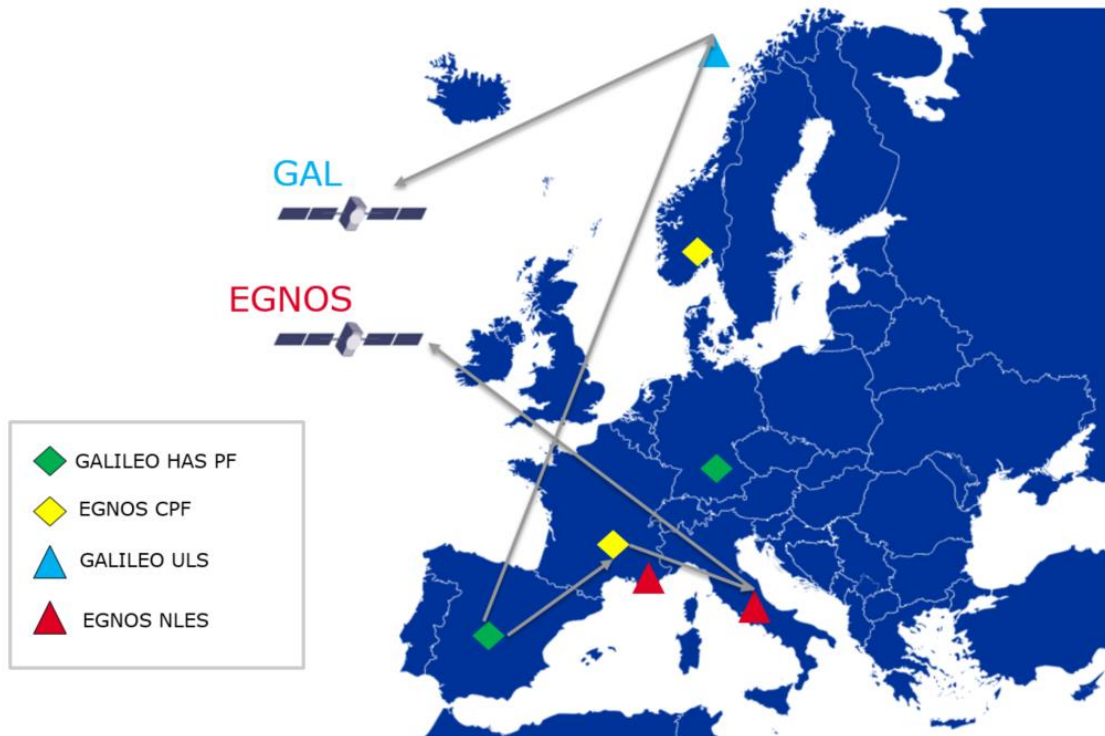

Figure 5-5. EGNSS Infrastructure

5.3. REGULATORY CONSIDERATIONS

Three main actors have been identified:

- First one is EUSPA, as the main E-GNSS programme coordinator, in charge of ensuring a reliable, safe and secure space-related service.
- Second actor is shown under the group "Autonomous Transportation Industry". This includes OEMs willing to integrate high Accuracy and ITHACA service provision into their integrity concept, targeting directly at the final user on automotive, maritime and rail sectors.
- The third independent and crucial actor is identified as "Certification authorities". During the process of service adoption by the Industry, Audits and certification process shall be required from all actors, especially when liability terms are on the table.

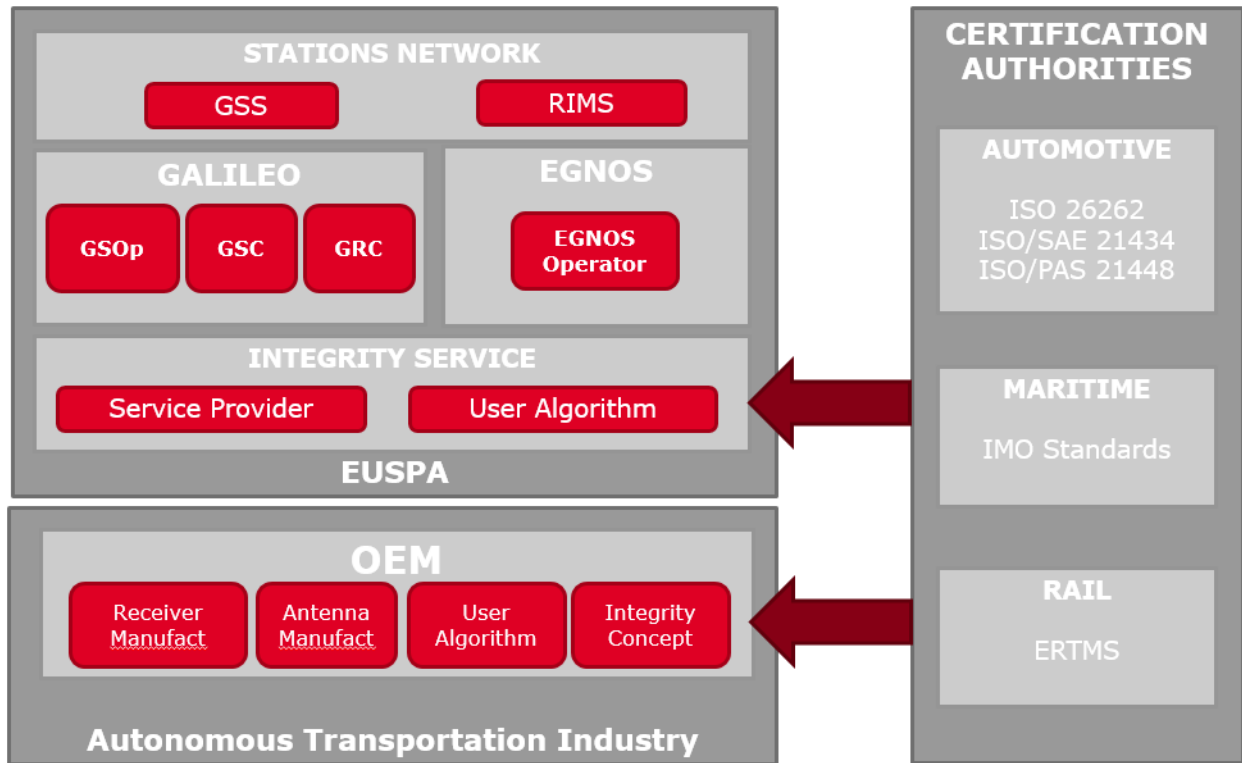

Figure 5-6. Main actors identified for ITHACA Service provision

5.4. SERVICE LIABILITY

Following the example in EGNOS for Aviation Users, it is key to establish certification processes for the EGNSS Integrity service specifically tailored for each specific sectors. An independent Authority should audit the terms of such certification, for which a Service Definition Document should be prepared in detail. ESA and EUSPA will not be held responsible or liable for any direct damage resulting of a misuse of the Service. In line with the study performed during task 2 following terms are proposed in terms of service liability:

EGNSS based Integrity service provider is responsible of the service when used under the following conditions:

- The user has access to Integrity message through ground channel dissemination or visibility of at least 6 augmented and monitored satellites (from Galileo or EGNOS constellation). Number of satellites in view is highly dependent on the user location and specially user environment, so this condition can include the possibility to receive corrections from any of the available dissemination means.
- In terms of accuracy requirements to be covered by the liability clauses, it is proposed to define align to following user scenarios:
 - Open sky inland dynamic user scenario: In order to ensure decimetre level accuracy, the user has visibility greater than 12 GPS and Galileo Satellites. This condition is considered necessary in order to cover the higher level of accuracy requirements. Accuracy within decimetre level might be ensured.
 - Urban/suburban/non open-sky dynamic user: In order to ensure accuracy under 1 meter, the user has visibility between 6 and 12 GPS and Galileo Satellites.
 - Open Sky seas: Visibility of 12 GPS and Galileo satellites is required.
- User algorithm has been tested and certified by the relevant competent authority (when applicable) following ISO26262, SOTIF and ISO 21434 development rules

- The service is "In Operation" mode.
- User algorithm is compliant with defined Integrity concept, including sensor hybridization according to specific standards for the correct usage of the defined integrity service (*)
- Receiver and antenna fulfil a set of minimum requirements
- The user is able to detect major local failure modes: ionosphere scintillations, high multipath, spoofing, jamming

Standard must include some mandatory aspects (minimum requirements for specification must be identified, and this process must include at least a detailed explanation on how the Integrity Service must be used at user level to ensure global Target Integrity Risk) but also some guidelines in order to allow certain flexibility for the final integrity concept. This flexibility is considered key to ease service adoption by the industry.

This group shall be led by Car manufacturers as ultimate responsible for the overall safety concept. An official institution such as EASA for aviation or ERA for rail could be created to be the regulator for the conformity assessment of the OBU, although this process could add a high level of complexity and time dependencies in the timeline. In the other hand, car makers usually perform certification processes by hiring expert institutions for support and external confirmation reviews as requested for the applicable ISO26262.

(*) At the moment of generation of this document no reference or standard PPP user algorithm with integrity has been defined up to know by any institution or standardization body. This is a field of active research, where tailored solutions are being defined for each particular application. However, it is considered that standardization and certification process is needed for liability aspects. At least, a minimum set of requirements can be set to the usage of integrity message in order to be able to apply some kind of liabilities:

- 1) OBU Integrity concept adequately interprets the usage of the integrity message in the PL
- 2) Risk allocation is compatible with message content

6. DECISION CRITERIA ANALYSIS FOR THE ROAD SECTOR

The “Integrity Service complementing EGNSS High Accuracy” developed under the ITHACA project will represent an opportunity for several stakeholders in the autonomous vehicle value chain, it will represent also an additional cost for some of them. The present reports aims to assess what will be the key Decision Criteria taken into account by the value chain to decide whether or not the Integrity concept should be implemented in their vehicles/devices (i.e. here the analysis is made for L5 vehicles).

The consortium has aimed to quantify costs and benefits which might play a role in the decision process for the three main stakeholder groups involved: manufacturers, end users, and service providers. Potential costs and benefits have been derived from publicly available reports and then refined and challenged via stakeholder consultation. The analysis has stressed that manufacturers (i.e. OEMs) will most likely require to invest additional funding in each OBU to include the integrity concept, however these additional costs could be balanced by the fact that they will not have to pay a subscription fee to commercial service providers. Regarding end-users, the drivers, the outcome will most likely depend on how OEMs will pass on, or not, additional costs to end-users (or if they will find another way to balance the additional cost of the integrity concept – for example, savings on commercial subscriptions, exploitation of users data, etc.).

Relating the costs related to the implementation and operation of the Integrity Service complementing Galileo High Accuracy, a slightly different approach has been followed. Operational, development and implementation costs of similar projects carried on in the frame of Galileo programme have been used as reference for analogous estimation.

The risk analysis is an important element of the project since costs might be higher or lower than expected depending on several parameters¹. Two major parameters are worth highlighting here: the number of vehicles equipped with the integrity concept and the business model implemented by OEMs for L5 vehicles. The analysis has indeed highlighted that there are opportunities for massive economy of scale. If the integrity concept will be implemented in large number of vehicles OBU-related costs will drop. It is worth noting that the costs faced by end-users will depend on the business model for L5 vehicles (i.e. ownership with a single CAPEX cost to buy the vehicle or rental/service based with a monthly subscription or pay-per-use).

The analysis has also stressed that the decision criteria, in addition to the costs and potential benefits, will be impacted by other elements: the window of opportunity, and reliability of the system among others. In order to ensure that the integrity concept will be on boarded by OEMs in their vehicles, it will be important to significantly progress on the development of the solution by 2026 for L3. It is expected by OEMs that if the integrity concept is not operational by then they will be strong commercial alternatives already implemented in their process for advanced automated vehicles. Another important element is the expected availability of the system, OEMs will not risk their reputation, and thus their financial profitability, with a system which has not proven reliable enough compared to commercial alternatives.

Table 6-1: Risk analysis for OEMs

	Costs for OEMs	Numbers validated via stakeholder consultation	Risk analysis
CAPEX	Qualified receiver	Around 25 EUR per vehicle	<ul style="list-style-type: none"> • Cost of the development and qualification of the receiver • Highly depending on the number of vehicles produced and equipped with the solution
	Solution implementation in the OBU (hardware, operating system, integration, etc.)	15 – 20 EUR per unit	<ul style="list-style-type: none"> • Highly depending on the number of vehicles produced and equipped with the solution

¹ For further detail, please refer to D410 report on the Decision Criteria Analysis on the Road sector

	Costs for OEMs	Numbers validated via stakeholder consultation	Risk analysis
OPEX	Maintenance of the OBU	2 – 3 EUR year/car (highly depending on the criticality of the inspection cost and on number of components to be assessed)	<ul style="list-style-type: none"> Highly depending on the number of vehicles produced and equipped with the solution

The risk for manufacturers involves the fact that the price of the receiver could potentially be an issue depending on several variables, such as how many vehicles will be produced and equipped with the service, as well as the time range when the service will be released. Indeed, considering the original value proposed (40 EUR), if considering few vehicles, it would not be considered a high cost, but when involving millions of vehicles, it would become much more expensive. For this reason, the estimation per vehicle can be particularly difficult. Indeed, the main concern should be on the cost of the qualification of the receiver, involving its development and final assessment. In addition, its cost will also be highly related to the numbers of vehicles to be considered: in the case of type approval cost being 100.000 EUR, for instance, if we consider the production of 10.000 units, additional cost would be 10 EUR, but if we consider the production of 100.000 units, then the additional costs per qualified receiver would be 1 EUR.

Similar logic can be applied regarding the solution implementation in the OBU and the maintenance of the OBU.

7. SERVICE ROADMAP ACTIVITIES

ITHACA aims at the Integrity Service provision with the goal to be adopted by wide autonomous transportation industries such as road, maritime or rail. In such a strategic sector in the years to come until the horizon 2030+, the success of the investment depends greatly on the acceptance of the integrity concept and subsequent demonstrations. The realization of such project involves important modifications to the current EGNSS infrastructure, which will have proportionate associated costs and need for investment. With these premises in mind, a series of Key Decision Milestones (KDM) have been defined aiming at mitigating the probability of this risk as much as possible.

These milestones have been identified at the end of each one of the development phases. They should really be understood as scheduled GO/NO GO evaluation processes in which a suitable board involving European Commission, EUSPA, Experts and other stakeholders analyse the outputs from the former phase and decide to continue with the next one.

Table 7-1. Ithaca Key Decision Milestones

	Milestone	Scope	Required inputs	Expected output
KDM-1	Service Concept Review	Exploratory projects about Integrity message generation feasibility (such as Ithaca) shall be analysed and compared. This will be used as the basis for the tender specification of Service demonstrator.	Exploratory projects such as ITHACA or ICHASE Final Reports	Green light and Tender specification for the service demonstrator
KDM-2	Service integrity concept demonstrator	Integrity concept for the service shall be developed and demonstrated. Tender specification shall include a compatible user algorithm prototype and have first tests results. Service demonstrator is considered a key aspect of the complete roadmap, as the expected times for the development of this service will probably overdue the window of opportunity for a strong entrance in the market. A demonstrator will help showing performances at user level of the achieved accuracy as well as the final size of the protection levels to be computed.	Tender specification for Service demonstrator	Integrity Service and User Terminal prototypes First test results.
KDM-3	User consultation platform assessment	Test results obtained by the demonstrator will be shown in a dedicated user consultation platform with relevant stakeholders. Public testing phase for potential interested key stakeholders, who shall be asked to test Integrity Service and User algorithm under certain circumstances in order to identify user needs coverage.	Test results Integrity Service and User Terminal prototypes Definition of key use cases	Key stakeholder report on demonstrator fulfilment of defined needs. Weakness identification.
KDM-4	System and Service Requirements Review	Targeting at the development of the Integrity Processing facility. This phase shall use as input the status of the current status for the GSS/RIMS network	Identified requirements from KDM-1, updated with outputs from KDM-3	Feasibility analysis of system and service requirements with respect to RIMS/GSS status

	Milestone	Scope	Required inputs	Expected output
KDM-5	System Design & Implementation	In this milestone, the implementation and validation of the Integrity Service is reviewed. This is by far the phase requiring a higher effort.	Green light from KDM-4 Complete Requirements specification	Implementation and Validation of needed Hardware/Software for Service Provision
KDM-6	System Certification	Certification of the system is required in order to be usable in target industries (especially for the automotive sector). Certification following ISO26262 or SOTIF is required.	System implemented according to certifiable standards	System is certified. Ready to go into operations
KDM-7	Initial operations phase	Based in the operational Global correction service from HAS Service Level #1	Certified system Operations infrastructure ready	Initial Operations assessment
KDM-8	Full Operational Capability Phase	Based in the Regional and Global correction Service from HAS Service Level #2	Satisfactory user needs fulfilment from KDM-7 Acceptable service adoption by the industry of Global Correction and Integrity system	Full Operational Capability

Several risks have been identified. Their corresponding mitigation actions have been taken into consideration for the final roadmap.

Table 7-2: Risk assessment matrix

Risk	Description	Proposed mitigation	Impact	Probability
Risk 01	Service adoption can be threatened by the industry if Protection Level provided is too high (i.e. greater than 5 m in nominal conditions). Protection levels are a combination of user environment assessment and the additional overbounding provided by the integrity service. Integrity Risk allocated to the Service should not result into very conservative bounds, as this could potentially result into not usable PLs.	During detailed integrity concept definition, bounds must be enough to cover with target integrity Risk taking into account final Protection Level size. Mitigation should be addressed as soon as possible, during Internal Test and validation of service demonstrator where typical bounds of the service and user algorithm can be tested from current RIMs/GSS data	Very High	Medium

Risk	Description	Proposed mitigation	Impact	Probability
Risk 02	<p>Automotive Industry reaches the conclusion that GNSS is not a key element for Level 5 autonomous applications (Inc. alternative technologies).</p> <p>Automotive sector a very challenging market, where the race towards a full autonomous car will present a very competitive environment. OEMs can invest in the development of additional sensors and technologies allowing relative positioning of the car with respect to road environment can surpass the need for High accuracy and Safe absolute positioning.</p>	<p>“Education” is a transversal and constant activity proposed during Service implementation roadmap, involving demonstration and open debate on the capabilities of GNSS for the automotive market.</p> <p>Integrity enabled solutions will involve service liabilities and can be key for navigation purposes, Failure modes diversification and ODD determination, among others.</p>	Very High	Medium
Risk 03	<p>Integrity Service provision is unfeasible (Available bandwidth, needed infrastructure)</p>	<p>The basis of the design of Ithaca service have been provided as part of the scope of the project. This has included analysis on the needed bandwidth of the new messages, need for infrastructure, et. However, these points shall be confirmed during “Service Demonstrator” phase, where the feasibility of the complete service implementation shall be made evident.</p>	High	Low
Risk 04	<p>Galileo HAS Service Level #2 FOC is not reached, blocking ITHACA’s possibility to meet stringent performance user requirements.</p> <p>The materialization of this risk would mean that only Global corrections and integrity may be offered to the final users. This would require a redesign of OBU concept targeting at lower final user requirements.</p>	<p>During “Education” phase, the added value of the Global integrity corrections shall be also put into value.</p> <p>Another possible mitigation add the validation of the User terminal demonstrator including only global corrections in order to have a valid assessment of reached performances.</p>	High	Medium
Risk 06	<p>EGNOS E5b not feasible as dissemination means.</p> <p>The cause could be a change of plans within EGNOS evolution roadmap. The materialization of this risk could mean a lack of robustness regarding the integrity data provision</p>	<p>User level requirements must account in the service provision the possibility of limited dissemination means.</p>	Medium	Medium
Risk 07	<p>Size of the potential market to justify the equipment in specific vehicle models (just EU).</p> <p>Ithaca Service is aiming at covering users located in Europe. For OEMs, the final increment cost of service adoption (receiver, antenna, etc) must be analysed for their particular business case, taking into consideration that this investment cannot ensure the same service level in other attractive markets (USA, China, Japan)</p>	<p>Mitigation for this risk is based on the simplicity of the receiver and antenna requirements (i.e extra frequencies needed). In general, low cost receiver and antenna already take part of standard setup of any car, so the simplicity in the delta cost on this equipment is considered a must for service provision</p>	High	Medium

Risk	Description	Proposed mitigation	Impact	Probability
Risk 08	Dependency with standardization bodies could impact in the operational timeline of the project causing milestone delays	Mitigation for this risk is regarding to timeline planning , where these activities should start before some critical Key Decision Milestones, in order to advance the work as much as possible.	Medium	High
Risk 09	Difficulties during OBU Certification process. Current state of the art GNSS integer and high accuracy is still in a continuous evolution and improvement. Certification process must account for different algorithm design choices that can provide the flexibility to include different solutions. An excessively constrained standard could mean a negative impact in the service adoption by the industry.	During the certification process , it is recommended to identify minimum requirements to ensure a correct usage of Ithaca's integrity message, but leaving somehow a margin of improvement for the GNSS algorithm as well as the risk allocation to the rest of the sensors. The possibility of broadcasting integrity data to different TIRs has also been assessed as part of the project, and it is recommended to assess this possibility in the Service demonstrator	Medium	Medium

Table 7-3. ITHACA project Risk Matrix

		Impact				
		Very Low	Low	Medium	High	Very High
Probability	Very High					
	High			RISK 08		
	Medium			RISK 06 RISK 09	RISK 04 RISK 07	RISK 01 RISK 02
	Low				RISK 03	
	Very Low					

In order to be able to fulfil the challenging user needs regarding integrity, an analysis has been performed regarding current EGNSS systems showing the need to perform some system upgrades. Roadmap is divided into 3 groups of activities

- **Integrity Service Design & Implementation:** This group of activities can be carried out under the responsibility of the chosen contractor or consortium. Input data or system ICDs might be required to support design or implementation activities.
- **Roadmap Full Operational Capability:** For this group of activities, close collaboration with current operational projects is needed. The most important activity within this timeline is the integration of the Integrity message generator into GSC operations.
- **E-GNSS External dependencies:** This group of activities are considered needed in order to ensure a successful operation of the Integrity service, but responsibility is out of ITHACA's proposed scope. EUSPA/EC is considered in charge of these activities which shall have their own independent roadmaps.
- Some activities are currently ongoing. It is the case of the Service concept analysis (through ITHACA and other parallel projects) and the Galileo HAS Service Level 1 Initial Operations. These activities are signalled with a curved line in the top edge of the corresponding time box.
- Main activities are represented by grey time boxes whose length is representative of the estimated effort required. Key decision milestones have no associated estimated effort (red boxes).
- Whenever a dependency is identified, it is noticed with a red Arrow.

We are currently observing a growing trend on the use of HA + Safe positioning solutions with many OEM/Tier1 distributing RFI/RFPs with target dates for production around 2025-2027. The window of opportunity is clear, and later availability would cause a transition from commercial providers to this service, but the process will be for sure slower since the commercial services are typically contracted for 8-10 years periods.

Regarding EGNSS it is hard to define a realistic plan targeting an operational service in 2025, goal should be to provide an entry level service for Automotive L3 in 2026-2027, targeting Automotive L4 and L5 in a longer timeframe (2030+)

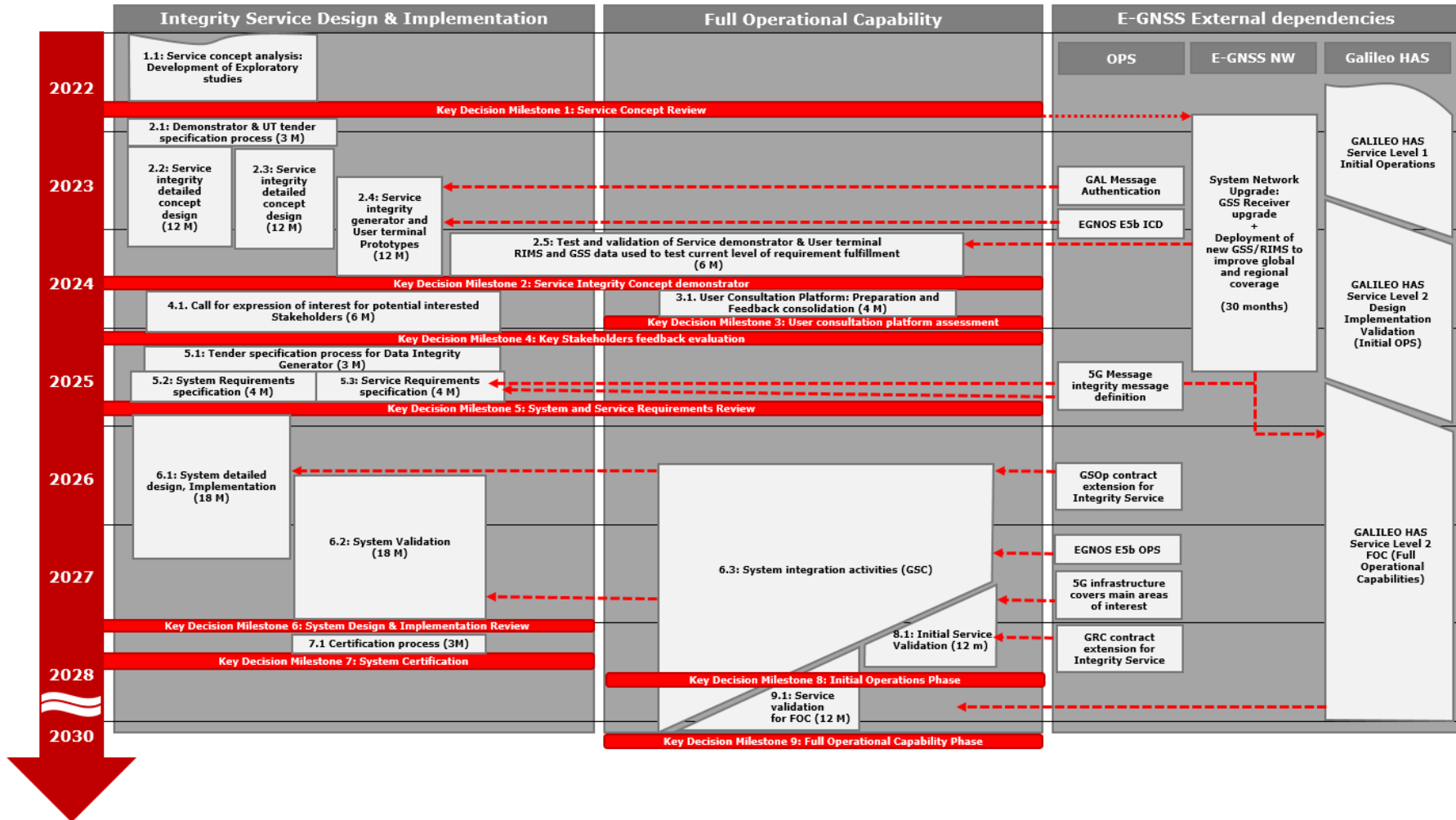

Figure 7-1. ITHACA service proposed roadmap overview

8. RECOMMENDATIONS FOR FUTURE WORK

During Task 5 a preliminary roadmap has been proposed in order to achieve Full Operational capability by 2030. During this roadmap, several Key Decision Points have been defined including the involvement of relevant stakeholders and public demonstrations and test reviews with the intention on gaining trust on the Service and offering to the private sector a viable solution for autonomous driving technologies.

Aside from following the plan proposed, following recommendations can be done:

- Analysis on the exploratory projects should be carefully performed to assess the feasibility for the overall initiative. Main key points should be studied and discussed with relevant stakeholders (EUSPA, European Commission, etc)
- Success on user requirements fulfillment is closely related to E-GNSS ionosphere corrections provision. Therefore, a close collaboration between roadmaps should be considered from the beginning, specifically in the approach to be followed to enhance current station network.
- It is as well proposed to perform experimental analysis (including user algorithm prototypes) with different network configurations, as the proposed sites may not be available during the deployment activities.
- In the same line, the strategy to include Ionosphere corrections will highly impact in the total length of the HAS message, and the corresponding increase of integrity iono related fields. This could not be compatible with the current SIS ICD at the desired rate for the navigation message update. This study should be performed taking into consideration the required parameters to be included for the IONO corrections.
- As stated above, it is considered quite unlikely that OEMs across the studied sectors would use a standardized user integrity concept including the proposed sensor hybridization. Most likely, each company will develop their own. Nevertheless, it is considered important to demonstrate the concept including a validated user algorithm in order to engage relevant stakeholders. This is the main goal for the Service demonstrator.
- At the moment of generation of this document no reference or standard PPP user algorithm with integrity has been defined up to know by any institution or standardization body. This is a field of active research, where tailored solutions are being defined for each particular application. However, it is considered that standardization and certification process is needed for liability aspects. At least, a minimum set of requirements can be set to the usage of integrity message in order to be able to apply some kind of liabilities:
 - 1) OBU Integrity concept adequately interprets the usage of the integrity message in the PL
 - 2) Risk allocation is compatible with message content
- Validation of the most stringent accuracy performance requirements can potentially mean a high cost in terms of required effort, as identified user needs are sometimes more stringent than current state of the art. Therefore, it is suggested to propose more relaxed targets that nevertheless can provide added value in the Demonstrator phases to show the user consultation platform.
- The motivation for stakeholder involvement is considered to highly depend on what is achieved by the demonstrator, on the investment and what would be the ROI. The more details provided, the more interesting would be for the motivation and identification to relevant stakeholders.
- For the development of the detailed Service Integrity concept, it is suggested to involve research institutes currently working on these topics in order to have an objective evaluation of the tests results.

9. DOCUMENTS AND ACRONYMS

9.1. REFERENCE DOCUMENTS

Table 9-1 – List of deliverables for ITHACA project.

Ref.	Title	Code	Version	Date
[D110]	Integrity for EGNSS High Accuracy Domain Analysis and user Needs for the Road Sector	D110	1.5	12/12/2022
[D210]	User Integrity Concept Analysis	D210	2.4	12/12/2022
[D220]	EGNSS Mission Requirements	D220	2.4	12/12/2022
[D230]	Receiver Model Requirements	D230	2.4	12/12/2022
[D240]	Test Campaign Requirements	D240	2.4	12/12/2022
[D310]	Integrity Service Complementing EGNSS High Accuracy Definition	D310	2.2	12/12/2022
[D410]	Decision Criteria Analysis in the road sector	D410	2.2	12/12/2022
[D510]	Service Roadmap	D510	1.2	12/12/2022

Table 9-2 – List of reference documents.

Ref.	Title	Code	Version	Date
[RD.1]	ISO/PAS 21448:2019, Road vehicles—Safety of the intended functionality	ISO/PAS 21448:2019	1	2019
[RD.2]	Road vehicles – Functional Safety	ISO 26262: 2018		2018
[RD.3]	ISO/SAE DIS 21434, Road vehicles – Cybersecurity engineering	ISO/SAE DIS 21434	N/A	2020
[RD.4]	EUSPA EO and GNSS Market Report 2022, issue 1		1	2022
[RD.5]	Report on Rail User Needs and Requirements EUSPA	GSA-MKD-RL-UREQ-250286	3.0	01/08/2021
[RD.6]	Resolution A.915 (22): Revised Maritime Policy and Requirements for a Future Global Navigation Satellite System (GNSS).	N/A	N/A	29/11/2001
[RD.7]	Report on Maritime and Inland waterways User Needs and Requirements EUSPA	GSA-MKD-MAR-UREQ-229399	3.0	01/08/2021
[RD.8]	SEASOLAS Final Report			2018
[RD.9]	"GNSS Antenna Calibration –Current Status", G. Wübbena, M. Schmitz, J. Wübbena, (Geo++ GmbH), 2017			2018
[RD.10]	"VehiCal – GNSS Antenna Calibration for Cars", Jannes B.Wübbena, Alexander Nietsch, Norbert Matzke, Temmo Wübbena, Gerhard Wübbena (Geo++GmbH), Proceedings of the 34th International Technical Meeting of the Satellite Division of The Institute of Navigation (ION GNSS+ 2021)			2021

9.2. ACRONYMS AND DEFINITIONS

Acronyms used in this document and needing a definition are included in the following table:

Table 9-3: Acronyms

Acronym	Definition
AD	Applicable Document Autonomous Driving
ADS	Automated Driving System

Acronym	Definition
ADAS	Advanced Driver Assistance Systems
AL	Alert Limit
ALC	Active Lane Control
ATP	Automatic Train Protection
ATO	Automatic Train Operation (ATO)
AoU	Assumptions of Use
ARAIM	Advanced Receiver Integrity Monitoring
ASIL	Automotive Safety Integrity Level
ASPICE	Automotive SPICE
CAPEX	CApital EXpentiture
CAS	Commercial Authentication Service
CBA	Cost Benefit Analysis
CFI	Customer Furnished Items
CMD	Cold Movement Detection
COTS	Commercial Off-The-Shelf
CP	Crossroad Passing
CS	Commercial Service
DAL	Design Assurance LLevel
DDL	Document Deliverable List
DFA	Dependent Failure Analysis
DIA	Development Interface Level
DIL	Deliverable Item List
DOC	Depth Of Coverage
E2E	End to End
EBS	Electronic Braking System
EC	European Commission
ECU	Electronic Control Unit
EDAS	EGNOS Data Access Service
eGAS	Electronic Gas Pedal
EGNOS	European Geostationary Navigation Overlay Service
EGNOSHA	EGNOS High Accuracy H2020 Mission and Services Study
EGNSS	European Global Navigation Satellite System
ENISA	European Union Agency for Cybersecurity
ERTMS	European Rail Traffic Management System
ESA	European Space Agency
EU	European Union
EUSPA	European Union Agency for the Space Programme
FDE	Fault Detection and Exclusion
FDTI	Fault Detection Time Interval
FMDEA	Failure Modes, Effects and Diagnostic Analysis
FMEA	Failure Modes and Effects Analysis
FMECA	Failure Modes, Effects and Criticality Analysis
FOC	Full Operational Capability
FR	Final Review

Acronym	Definition
FTA	Fault Tree Analysis
FTTI	Fault Tolerant Time Interval
FUSA	Functional Safety
GCC	Ground Control Centre
GEO	Geostationary Earth Orbit
GMV	GMV Aerospace and Defence S.A.U.
GNSS	Global Navigation Satellite System
GPS	Global Positioning System
GSA	European GNSS Agency (currently, EUSPA)
GSC	Galileo Service Center
GSS	Galileo Sensor Station
H2020	Horizon 2020
HA	High-Accuracy
HADG	High-Accuracy Data Generator
HAL	Horizontal Alert Limit
HAPS	High-Altitude Pseudo Satellite
HARA	Hazard Analysis and Risk Assessment
HAS	High Accuracy Service
HD	High Definition (used as HDMaps)
HiL	Hardware in Loop
HMI	Human Machine Interface
HW	Hardware
I&CoS	Integrity and Continuity of Service
ICAO	International Civil Aviation Organisation
ICD	Interface Control Document
IEC	International Electrotechnical Commission
IGSO	Inclined Geosynchronous Orbit
IMO	International Maritime Organization
IMU	Inertial Measurements Unit
IoT	Internet of Things
IR	Integrity Risk
ISO	International Standardisation Organisation
ITC	Inland Transport Committee
ITIL	Information Technology Infrastructure Library
ITT	Invitation to Tender
ITS	Intelligent Transport System
IVS	Integrated Vehicle Safety
KOM	Kick-Off Meeting
KPI	Key Performance Indicator
LF	Latent Fault
LFM	Latent Fault Metric (LFM)
LIDAR	Laser Imaging Detection And Ranging
LOS	Line Of Sight
MEO	Medium Earth Orbit

Acronym	Definition
NMA	Navigation Message Authentication
OBU	On-Board Unit
ODD	Operational Design Domain
OEM	Original Equipment Manufacturer
OPEX	OPerational EXpenditure
OS	Open Service
OSNMA	Open Service Navigation Message Authentication
PDF	Portable Document File
PDR	Preliminary Requirements Review
PL	Protection Level
PM	Progress Meeting
PMD	Probability of MissDetection
PMP	Project Management Plan
PNT	Positioning, Navigation and Timing
PPP	Precise Point Positioning
PR	Progress Report
PRN	Pseudorandom Noise
PRR	Preliminary Requirements Review
PVT	Position, Velocity and Time
QA	Quality Assurance
QAP	Quality Assurance Plan
QAM	Quality Assurance Manager
QM	Qualtiy Manamement
QMS	Quality Management System
QR	Qualification Review
R&D	Research and Development
RAIM	Receiver Autonomous Integrity Monitoring
RAMS	Reliability, Availability, Maintainability and Safety
RD	Reference Document
RF	Residual Fault
RID	Review Item Discrepancies
RIMS	Ranging Integrity Monitoring Station
RINEX	Receiver Independent Exchange
RM	Review Meeting
RTCM	Radio Technical Commission for Maritime services
RTK	Real Time Kinematics
SAE	Society of Automotive Engineers
SARPs	Standards And Recommended Practices
SBAS	Satellite-Based Augmentation Systems
SDD	Service Definition Document
SF	Safe Fault
SIL	Safety Integrity Level
SIS	Signal In Space
SLA	Service Level Agreement

Acronym	Definition
SLAM	Simultaneous Localization And Mapping
SoC	System-on-Chip
SoL	Safety of Life
SOTIF	Safety of the Intended Functionality (ISO/PAS 21448:2019)
SPAN	Southern Positioning Augmentation Network
SPF	Single Point Fault
SPFM	Single Point Fault Metric
SPICE	Software Process Improvement and Capability Determination
SPS	Standard Positioning Service
SRR	System Requirements Review
STARS	Satellite Technology for Advanced Railway Signalling
SW	Software
TBC	To Be Confirmed
TBD	To Be Defined
TECU	Total Electron Content Units
TTA	Time To Alert
UAV	Unmanned Aerial Vehicle
UCP	User Consultation Platform
URA	User Range Accuracy
V2V	Vehicle To Vehicle communication
V2I	Vehicle To Infrastructure communication
V2x	Vehicle To everything communication
VDES	VHF Data Exchange System
VMAD	Validation Method for Automated Driving
WWRNS	World Wide Radio Navigation System

END OF DOCUMENT